



ECG Cables & Leadwires

Compliance with

ANSI/AAMI SP10
 EN 60604-1
 ISO 10993-1
 ISO 10993-5
 ISO 10993-10

Package

Reusable: 1 pcs/bag
 Disposable: 24 pcs/box for neonatal size, and 10 pcs/box for others

Lead Position Marked



5 Lead: A
 Standard AHA

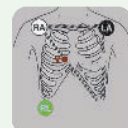

3 Lead: H
 Standard AHA

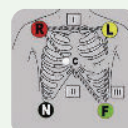

5 Lead: I
 Standard IEC

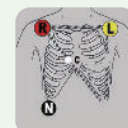

3 Lead: IH
 Standard IEC



Instrument Connector







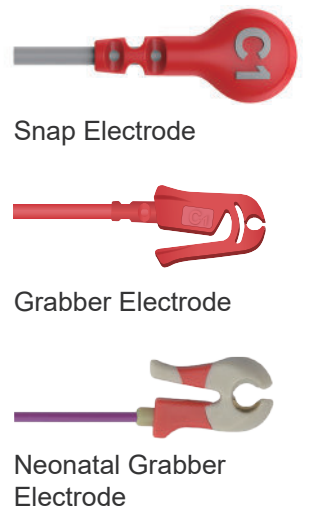
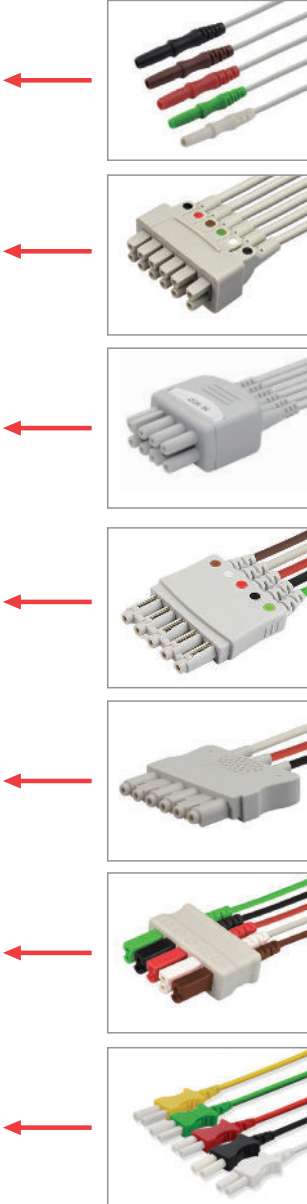
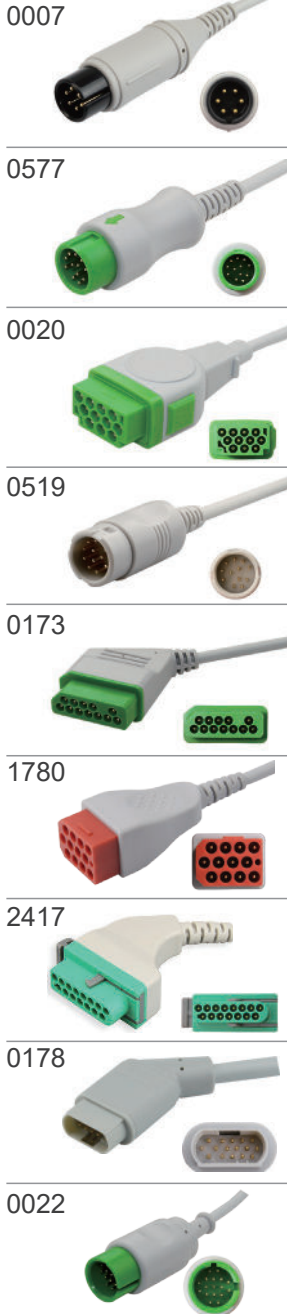

Yoke Type

Leadwire Connector

Patient end connector



CONTENTS

1. Disposable ECG Electrodes	123	
2. Disposable ECG Leadwires	133	
3. One Piece ECG Cables	137	
4. ECG Trunk Cables	145	
5. ECG Leadwires	155	
6. ECG Telemetry Leadwires	165	
7. Holter Recorder ECG Cables with Leadwires	170	
8. Defibrillation ECG Cables	179	
9. Single-use Defibrillation Pads	181	

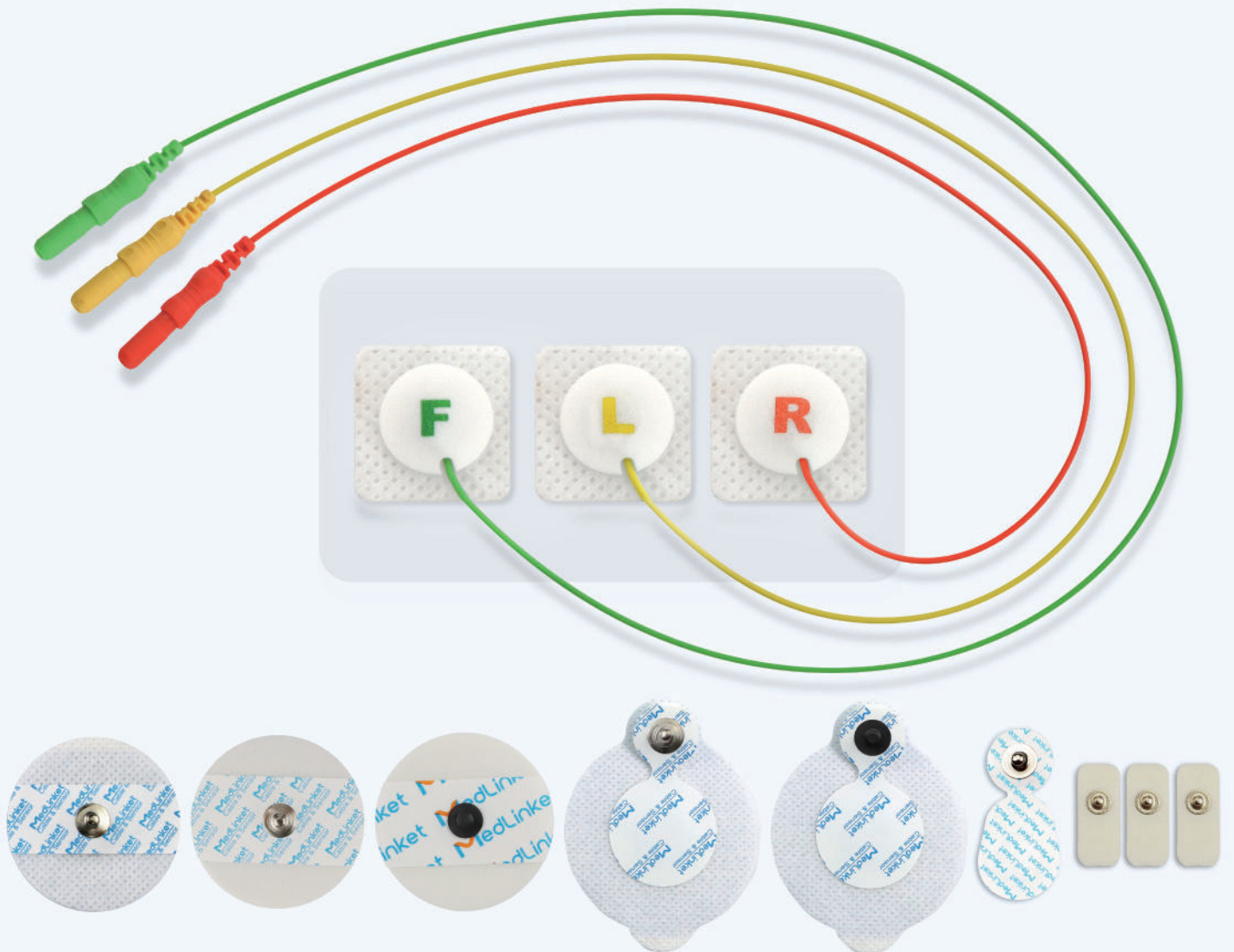

1 Disposable ECG Electrodes

Product Features

1. The product is suitable for different patients; newborns, children, adults;
2. The product is suitable for different departments; such as diagnosis, monitoring, telemetry, DR, CT, MRI (X-ray);
3. High-quality medical pressure-sensitive adhesive provides strong adhesion, and will not fall off easily even when sweating;
4. Use unique polymerization technology to reduce skin rashes and skin disorders;
5. Latex free, plasticizer free, mercury free.

According to the different needs of customers, we can provide customized designs of different materials, shapes and patterns.



OEM Manufacturer & Models	Product Guide	Order Code	Descriptions	Applicable Place	Package
Disposable ECG electrodes (with wire)					
Monitor with ECG main cable adapted to Din-type splitter		V0014-C0243A	3 LD, AHA, 600 mm	All ECG monitoring, ECG studio (diagnosing Holter)	1set/bag 25set/box
		V0014-C0243I	3 LD, IEC, 600 mm		
		V0014-C0245A	5 LD, AHA, 600 mm		
		V0014-C0245I	5 LD, IEC, 600 mm		
		V0014C-C0403A	3 LD, AHA, 1000 mm		
		V0014C-C0403I	3 LD, IEC, 1000 mm		
Disposable Radiolucent ECG electrodes (with wire)					
Monitor with ECG main cable adapted to Din-type splitter		V0015-C0243A	3 LD, AHA, 680 mm	DR (x-ray)- CT (x-ray)- CR(x-ray)- DSA(x-ray)	1set/bag 25set/box
		V0015-C0243I	3 LD, IEC, 680 mm		
		V0015-C0603A	3 LD, AHA, 1200 mm		
		V0015-C0603I	3 LD, IEC, 1200 mm		
		V0015-C0845A	5 LD, AHA, 1200 mm		
		V0015-C0845I	5 LD, IEC, 1200 mm		
ECG Patient monitor (Radiotransparent)		V0015-C0485I	5 LD, IEC, 1200 mm		
		V0015-C0485A	5 LD, AEC, 1200 mm		
OEM Manufacturer & Models	Connector	Yoke (Leads Side)	OEM#	Order Code	Descriptions
Compatible Comen					
C60				EC404-3AI	Neonatal DIN 3-lead, AHA/IEC, 2.7 m/9 ft.
Compatible Drager					
Infinity Kappa series, Gamma series, Delta series, Vista series, etc.			MS20094	EQ091-6AI	16-pin connector, 5 Lead,AHA/IEC,2.5m
				EC080-3AI	6-pin connector, used with Din leads, 3 Lead,IEC/AHA,2.5m











OEM Manufacturer & Models	Connector	Yoke (Leads Side)	OEM#	Order Code	Descriptions
Compatible Mindray					
BeneView, IPM, ePM, IMC, UMEC Series				EC050-3AI	Neonatal DIN 3-lead, AHA/IEC, 2.7m/9ft
PM Series, MEC Series, Datascope XL Series				EC020-3AI	Neonatal DIN 3-lead, AHA/IEC, 2.7m/9ft
Compatible Nihon Kohden					
Nihon Kohden LifeScope AB5M5105, B5M5135, Life Scope PB5M-4103K, B5M-4113; Life Scopel B5M-2301K, B5M-2303, etc.				EC055-3AI	Neonatal DIN 3-lead, AHA/IEC, 2.7m/9ft
Compatible Philips					
Philips MP series (MP20/30/40/50/60/70/80/90), MX series (MX400/450/500/550)etc				EC023-3A	Neonatal DIN 3-lead, AHA/IEC, 2.7m/9ft
Compatible GE					
GE Marquette: CARESCAPE series: B450, B650, B850 etc. DASH series: B20, B40, B105, B125, B155 etc.			2106306-001/ 2017004-001 2106306-003/ 2017004-003	EC007-3AI	11-pin connector, used with Din leads, 3 Lead, IEC/AHA, 2.7m/9ft

The ECG Electrode for Allergy Relief





Product Guide	Order Code	Descriptions					Applicable Place	Patient size
		Backing Material	Connector Material	Gel type	Size(mm)	Packaging		
	V0014AL	Non-woven Fabric	4mm metal snap ECG electrode	Silica gel	Φ50	25pcs/bag, 250pcs/box	ECG diagnosis, ECG monitoring, ECG workstation, Telemetry (Holter) ECG	Adult/ Pediatric
	V0015AL	Non-woven Fabric	Radiolucent, 4mm Carbon plastic snap ECG electrode	Silica gel	Φ50	25pcs/bag, 250pcs/box	CT(X-ray) DR(X-ray) DAS(X-ray) MRI	Adult/ Pediatric



Disposable ECG Electrodes

Product Guide	Order Code	Descriptions					Applicable Place	Patient size
		Backing Material	Connector Material	Gel type	Size(mm)	Packaging		
	V0014A	Non-woven Fabric	4mm metal snap ECG electrode	Wet (Hydrogel)	Φ50	25pcs/bag, 250pcs/box	ECG diagnosis, ECG monitoring, ECG workstation, Telemetry (Holter) ECG	Adult
	V0014AP	Foam material	4mm metal snap ECG electrode	Wet (Hydrogel)	Φ50	25pcs/bag, 250pcs/box		Adult
	V0014C	Non-woven Fabric	4mm metal snap ECG electrode	Wet (Hydrogel)	Φ30	25pcs/bag, 250pcs/box		Pediatric
	V0014CP	Non-woven Fabric	4mm metal snap ECG electrode	Wet (Hydrogel)	Φ42	25pcs/bag, 250pcs/box		Pediatric
	V0014C-I	Foam material	4mm metal snap ECG electrode	Wet (Hydrogel)	Φ25	25pcs/bag, 250pcs/box		Neonates
	V0014D	Foam material	2.5mm metal snap ECG electrode (Compatible Medlinket V0010N electrocardiograph adapter, connect 12-Led electrocardiograph banana plug	Wet (Hydrogel)	10*25	10pcs/bag, 500pcs/box		Neonates
	V0014A-H	Non-woven Fabric	4mm metal snap ECG electrode	Wet (Hydrogel)	70.5*55	20pcs/bag, 400pcs/box		Adult/ Pediatric
	9902040501	Foam material	4mm metal snap ECG electrode	Solid	29.2*22	20pcs/bag, 400pcs/box	BIS Module (Bispectral index) Telemetry (Holter) ECG	Adult

Disposable Radiolucent ECG Electrodes

	V0014A-RT	Foam material	4mm Carbon plastic snap ECG electrode	Wet (Hydrogel)	Φ50	25pcs/bag, 250pcs/box	CT(X-ray) DR(X-ray) DAS(X-ray) MRI	Adult/ Pediatric
	V0014B-RT	Foam material	4mm Carbon plastic snap ECG electrode	Wet (Hydrogel)	50*35	25pcs/bag, 250pcs/box		
	V0015AH	Non-woven Fabric	4mm Carbon plastic snap ECG electrode	Wet (Hydrogel)	70.5*55	20pcs/bag, 400pcs/box		
	V0015AL	Non-woven Fabric	4mm Carbon plastic snap ECG electrode	Silica gel	Φ50	25pcs/bag, 250pcs/box		



NEW

OEM Manufacturer & Models	ECG Trunk Cables		Adapter		Disposable ECG Electrodes	
	Product Picture	Order Code	Product Picture	Order Code	Product Picture	Order Code
Compatible Mindray: BeneVision N series, BeneView T series, IPM series, MEC series etc.		EJ050-5AI		EMAJ-5AI		1705101132 (AHA)
		EJ050-3AI		EMAJ-3AI		
Compatible Philips: MP series; MX series; SureSigns VM series (VM4,VM6,VM8). Compatible Goldway: CM series etc.		EDG073-5AI		EMADG-5AI		1705101131 (IEC)
		EDG073-3AI		EMADG-3AI		
Compatible GE Marquette: CARESCAPE series: B450,B650, B850 etc. DASH series: B20,B40,B105, B125,B155 etc.		EE007-5AI		EMAE-5AI		1705101152 (AHA)
				EMAE-3AI		
Drager Infinity Kappa series, Gamma series, Delta series, Vista series		EQ056-5AI		EMASM-3AI		94051162A(AHA) 94051162I(IEC)
				EMASM-5AI		
		EQ091-6AI		EMAQ-3AI		
				EMAQ-5AI		
				EMAQ-6AI		
				EMAQ-6AI		



ECG Radiolucent Lead Wires

Product Features

- ★ The wires and grabber clip are made of non-metallic conductive materials, connected with Radiolucent ECG electrode, suitable for X-ray imaging equipment, such as CR, DR, DSA, CT, etc.
- ★ Delivering the optimal signal, excellent trace quality and unobstructed views of the heart for fast, accurate cardiac diagnostic and imaging results.
- ★ Biocompatibility and latex free.









Traditional Leadwires













Radiolucent Leadwires



OEM Manufacturer & Models	Product Guide	OEM #	Order Code	Lead #	Descriptions
Philips HP Type ECG Leadwires Set					
Philips MP series(MP20/30/40/50/60/70/80/90), MX series(MX400/450/500/550)etc.	 		RDG040C5A	5-Ld	Radiolucent ECG Lead Wires, 69g Reusable, Grabber clip,AHA, 40 Inches
			RDG040C5I	5-Ld	Radiolucent ECG Lead Wires,69g, Reusable, Grabber clip, IEC, 40 Inches
			RDG040C3A	3-Ld	Radiolucent ECG Lead Wires, 47g, Reusable, Grabber clip, AHA, 40 Inches
			RDG040C3I	3-Ld	Radiolucent ECG Lead Wires, Reusable, Grabber clip, 47g, IEC, 40 Inches
Philips DIN Type ECG Leadwires Set					
PHILIPS MR400	 	9898031 93761	RC040C4A	4-Ld	DIN type, Radiolucent ECG Lead Wires, Reusable, Grabber clip, AHA, 40 Inches
			RC040C4I	4-Ld	DIN type, Radiolucent ECG Lead Wires, Reusable, Grabber clip, IEC, 40 Inches
Mindray EURO Type ECG Leadwires Set					
Mindray Benevision N series, BeneView T series, iMEC series, uMEC series, iPM series, ePM series etc.	 		RJ075C5A	5-Ld	Radiolucent ECG Lead Wires, Reusable, Grabber clip, AHA, 40 Inches, 72g
			RJ075C5I	5-Ld	Radiolucent ECG Lead Wires, Reusable, Grabber clip, IEC, 40 Inches, 57g
			RJ075C3A	3-Ld	Radiolucent ECG Lead Wires, Reusable, Grabber clip, AHA, 40 Inches, 57g
			RJ075C3I	3-Ld	Radiolucent ECG Lead Wires, Reusable, Grabber clip, IEC, 40 Inches, 57g

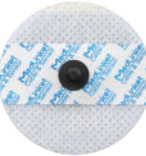

OEM Manufacturer & Models	Product Guide	Order Code	Descriptions	Applicable Place	Package
Disposable Radiolucent ECG electrodes (with wire)					
Monitor with ECG main cable adapted to Din-type splitter		V0015-C0243A	3 LD, AHA, 680 mm	DR (x-ray)- CT (x-ray)- CR(x-ray)- DSA(x-ray)	1set/bag 25set/box
		V0015-C0243I	3 LD, IEC, 680 mm		
		V0015-C0603A	3 LD, AHA, 1200 mm		
		V0015-C0603I	3 LD, IEC, 1200 mm		
		V0015-C0845A	5 LD, AHA, 1200 mm		
		V0015-C0845I	5 LD, IEC, 1200 mm		
ECG Patient monitor (Radiotransparent)		V0015-C0485I	5 LD, IEC, 1200 mm		
		V0015-C0485A	5 LD, AEC, 1200 mm		

OEM #	Product Guide	Order Code	Descriptions	Applicable Place	Applicable People
Disposable Radiolucent ECG Electrodes					
		V0014A-RT	Foam material, AAg/AgCL sensor, 50mm Diameter, 25pcs/bag, X-ray Disposable Radiolucent ECG Electrode	CT(X-ray) DR(X-ray) DAS(X-ray) MRI	Adult
		V0014B-RT	Foam material, Ag/AgCL sensor, 50*35mm Diameter, 25pcs/bag, X-ray Disposable Radiolucent ECG Electrode	CT(X-ray) DR(X-ray) DAS(X-ray) MRI	Adult
		V0015AL	Non-woven Fabric 4.0mm buton electrode Ag/AgCL sensor, 50mm Diameter, 25pcs/bag, X-ray transparent ECG electrode, full-gel	CT(X-ray) DR(X-ray) DAS(X-ray) MRI	Adult / Pediatric
		V0015AH	Non-woven Fabric, Disposable Radiolucent ECG Electrode, 20pcs/bag	CT(X-ray)- DR(X-ray)- DAS(X-ray)- MRI- Telemetry (Holter) ECG	Adult
		V0015GH	Non-woven Fabric, Disposable Radiolucent ECG Electrode, full-gel, 20pcs/bag	CT(X-ray)- DR(X-ray)- DAS(X-ray)- MRI- Telemetry (Holter) ECG	Adult







Disposable impedance electrode cables

Product Features

1. extra wide sensor site for enhanced impedance signal detection;
2. High quality conductive hydrogel with good adhesion to obtain better impedance signal.

Med-linket offers single-use impedance sensors with the advantages of non-invasive infection risk and simple use for continuous monitoring, without the need for professional training. It is suitable for a wide range of brands and models of equipment in the hospital.







OEM Manufacturer & Models	Product Guide	Order Code	Descriptions	Applicable Place
Impedance electrode cable				
A cardiac output monitor suitable for the ECG main cable of the Din-type splitter, such as Osypka		EC419-4I	4 LD, TPU Cable, 2.5 m	Anesthesiology, ICU, Operating room
		V0014A-C0234I	Black Red Green White, 610 mm	Anesthesiology, ICU, Operating room
Non-invasive cardiac output monitor, hemodynamic monitor		COE0001N	DIN 1.5 Connector, 0.65m	Anesthesiology, ICU, Operating room
Impedance cardiac output measurement system		COE0002A	4.0mm button electrode, Adult	Anesthesiology, ICU, Operating room
		COE0003A	4.0mm button electrode, Adult	Anesthesiology, ICU, Operating room







2 Disposable ECG Leadwires







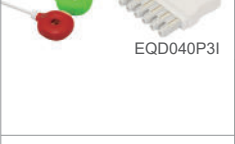

Product Advantages

Photo	Feature	Advantage
	Single Patient Use	Decreases the risk of cross contamination and improves patient care.
	Fully Shielded Leadwires Design	Reduces the risk of Electromagnetic Interference (EMI).
	Peelable Ribbon Cable Design	Prevents lead wire entanglement and can be customized to fit any patient's body size.
	Side button and visual connection design	(1) Provide clinicians with a locking and visualization mechanism to achieve faster, efficient and firm connections; (2) Clinically proven to reduce the risk of "leads off" false alarms.
	Easy to used electrode colors Lightweight smooth design	(1) Easy and quick lead placement; (2) Increase patient comfort.



Compatible Models	Product Guide	OEM #	Lead #	Descriptions	Order Code
Compatible Covidien					
Covidien (Bedside Monitoring)	 <p>END405P3I</p>	33103	3	Snap, 124 in. (315 cm), AHA	END405P3A
				Snap, 124 in. (315 cm), IEC	END405P3I
		33105 33105E	3	Grabber, 124 in. (315 cm), AHA	END405C3A
	Grabber, 124 in. (315 cm), IEC			END405C3I	
	5		Snap, 124 in. (315 cm), AHA	END405P5A	
		Snap, 124 in. (315 cm), IEC	END405P5I		
Covidien (Radiolucent Monitoring)	 <p>RND405C3I</p>	33136R36	3	Grabber, 124 in. (315 cm), AHA	RND405C3A
				Grabber, 124 in. (315 cm), IEC	RND405C3I
		5	Grabber, 124 in. (315 cm), AHA	RND405C5A	
			Grabber, 124 in. (315 cm), IEC	RND405C5I	
Compatible DIN Type Connector					
DIN Type	 <p>M3915A (PHILIPS)</p>		3	Snap, 40 in. (100 cm), AHA	ECD040P3A
				Snap, 40 in. (100 cm), IEC	ECD040P3I
	900716-001 (GE)	3	Grabber, 40 in. (100 cm), AHA	ECD040C3A	
			Grabber, 40 in. (100 cm), IEC	ECD040C3I	
Compatible Drager					
Drager Gamma/ Gamma XL/ Gamma X XL Delta/Delta XL Kappa/Kappa XLT Vista/Vista XL	 <p>EQD040P3I</p>	MS14556	3	Snap, 40 in. (100 cm), AHA	EQD040P3A
				Snap, 40 in. (100 cm), IEC	EQD040P3I
		MP00877 MP00875	3	Grabber, 40 in. (100 cm), AHA	EQD040C3A
				Grabber, 40 in. (100 cm), IEC	EQD040C3I
		MS14560 MS14559	5	Snap, 40 in. (100 cm), AHA	EQD040P5A
				Snap, 40 in. (100 cm), IEC	EQD040P5I
	MP00881 MP00879	5	Grabber, 40 in. (100 cm), AHA	EQD040C5A	
			Grabber, 40 in. (100 cm), IEC	EQD040C5I	
	 <p>EQD040P6A</p>	MS14682 MS14683	6	Snap, 40 in. (100 cm), AHA	EQD040P6A
				Snap, 40 in. (100 cm), IEC	EQD040P6I
		MP03123 MP03122	6	Grabber, 40 in. (100 cm), AHA	EQD040C6A
				Grabber, 40 in. (100 cm), IEC	EQD040C6I
		3	Grabber, 36in(0.92m), AHA	EQ035C3A	
			Grabber, 36in(0.92m), IEC	EQ035C3I	



Compatible Models	Productor Guide	OEM #	Lead #	Descriptions	Order Code	
Compatible Datex (ASP Style Types)						
Bedside Monitoring	 EHD040P3I		3	Snap, 40 in. (100 cm), AHA	EHD040P3A	
				Snap, 40 in. (100 cm), IEC	EHD040P3I	
	 EHD040P5A			3	Grabber, 40 in. (100 cm), AHA	EHD040C3A
					Grabber, 40 in. (100 cm), IEC	EHD040C3I
				5	Snap, 40 in. (100 cm), AHA	EHD040P5A
					Snap, 40 in. (100 cm), IEC	EHD040P5I
5	Grabber, 40 in. (100 cm), AHA	EHD040C5A				
	Grabber, 40 in. (100 cm), IEC	EHD040C5I				
Compatible GE Multi-link						
Bedside Monitoring	 EED029P3I	E9008LF E9008LH	3	Snap, 29 in. (74 cm), AHA	EED029P3A	
				Snap, 29 in. (74 cm), IEC	EED029P3I	
	 EED029P5A	E9003CL E9003CN	3	Grabber, 29 in. (74 cm), AHA	EED029C3A	
				Grabber, 29 in. (74 cm), IEC	EED029C3I	
		E9008KB E9008KD	5	Snap, 29in. (74 cm), AHA	EED029P5A	
				Snap, 29in. (74 cm), IEC	EED029P5I	
E9002ZW E9002ZZ	5	Grabber, 29in. (74 cm), AHA	EED029C5A			
		Grabber, 29in. (74 cm), IEC	EED029C5I			
Compatible Mindray (China)						
Bedside Monitoring	 EJD040P3I	0010-30-42734 0010-30-42733	3	Snap, 40 in. (100 cm), AHA	EJD040P3A	
				Snap, 40 in. (100 cm), IEC	EJD040P3I	
	 EJD040P5I	0010-30-42731 0010-30-42732	3	Grabber, 40 in. (100 cm), AHA	EJD040C3A	
				Grabber, 40 in. (100 cm), IEC	EJD040C3I	
		0010-30-42735 0010-30-42736	5	Snap, 40 in. (100 cm), AHA	EJD040P5A	
				Snap, 40 in. (100 cm), IEC	EJD040P5I	
0010-30-42727 0010-30-42730	5	Grabber, 40 in. (100 cm), AHA	EJD040C5A			
		Grabber, 40 in. (100 cm), IEC	EJD040C5I			
Compatible Philips						
Bedside Monitoring	 EDGD040P3I	M1673A M1674A	3	Snap, 40 in. (100 cm), AHA	EDGD040P3A	
				Snap, 40 in. (100 cm), IEC	EDGD040P3I	
	 EDGD040P5A	989803173121 989803174201	3	Grabber, 40 in. (100 cm), AHA	EDGD040C3A	
				Grabber, 40 in. (100 cm), IEC	EDGD040C3I	
		M1644A M1645A	5	Snap, 40 in. (75cm/100 cm), AHA	EDGD040P5A	
				Snap, 40 in. (75cm/100 cm), IEC	EDGD040P5I	
989803173131 989803174211	5	Grabber, 40 in. (75cm/100 cm), AHA	EDGD040C5A			
		Grabber, 40 in. (75cm/100 cm), IEC	EDGD040C5I			
Philips IntelliVue M2600B			5	Grabber,5PIN,36in(92cm), AHA	HFD040S5A	
				Grabber,5PIN,36in(92cm), IEC	HFD040S5I	
Compatible Siemens						
	 ESMD040P3I		3	Snap, 40 in. (100 cm), AHA	ESMD040P3A	
				Snap, 40 in. (100 cm), IEC	ESMD040P3I	
			3	3	Grabber, 40 in. (100 cm), AHA	ESMD040C3A
					Grabber, 40 in. (100 cm), IEC	ESMD040C3I



Compatible Models	Product Guide	OEM #	Lead #	Descriptions	Order Code
Compatible Siemens					
			5	Snap, 40 in. (100 cm), AHA	ESMD040P5A
				Snap, 40 in. (100 cm), IEC	ESMD040P5I
			5	Grabber, 40 in. (100 cm), AHA	ESMD040C5A
				Grabber, 40 in. (100 cm), IEC	ESMD040C5I
Compatible Spacelabs					
90309, 90367, 90367 Ultraview, 90369, 90369 Ultraview, 90492, 90496, 90496 Ultraview		700-0007-02 700-0007-03	3	Snap, 40 in. (100 cm), AHA	ELD040P3A
				Snap, 40 in. (100 cm), IEC	ELD040P3I
		700-0006-02 700-0006-03	3	Grabber, 40 in. (100 cm), AHA	ELD040C3A
				Grabber, 40 in. (100 cm), IEC	ELD040C3I
		700-0007-10 700-0007-09	5	Snap, 40 in. (100 cm), AHA	ELD040P5A
				Snap, 40 in. (100 cm), IEC	ELD040P5I
		700-0006-10 700-0006-11	5	Grabber, 40 in. (100 cm), AHA	ELD040C5A
				Grabber, 40 in. (100 cm), IEC	ELD040C5I

Compatible Brand	ECG Trunk Cables		Adapter		Disposable ECG Electrodes	
	Product Picture	Order Code	Product Picture	Order Code	Product Picture	Order Code
Compatible Mindray: BeneVision N series, BeneView T series, IPM series, MEC series etc.		EJ050-5AI		EMAJ-5AI		EMAD040P3A
		EJ050-3AI		EMAJ-3AI		
Compatible Philips: MP series; MX series; SureSigns VM series (VM4, VM6, VM8). Compatible Goldway: CM series etc.		EDG073-5AI		EMADG-5AI		EMAD040P3I
		EDG073-3AI		EMADG-3AI		
Compatible GE Marquette: CARESCAPE series: B450, B650, B850 etc. DASH series: B20, B40, B105, B125, B155 etc.		EE007-5AI		EMAE-5AI		EMAD040P5A
				EMAE-3AI		
Drager Infinity Kappa series, Gamma series, Delta series, Vista series		EQ056-5AI		EMASM-3AI		
				EMASM-5AI		
		EQ091-6AI		EMAQ-3AI		
				EMAQ-5AI		
				EMAQ-6AI		EMAD040P5I

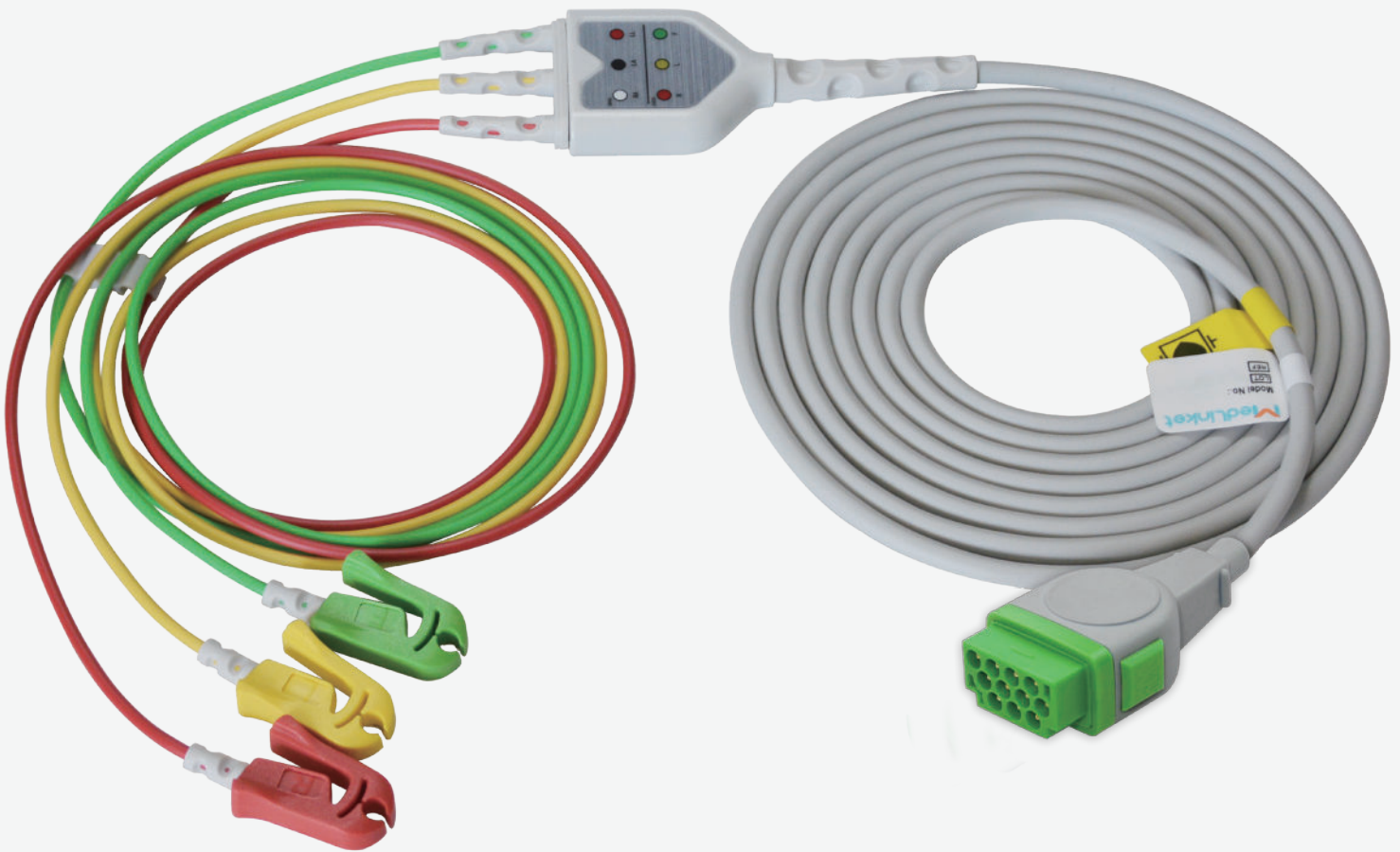

3 One Piece ECG Cables

Type Designation

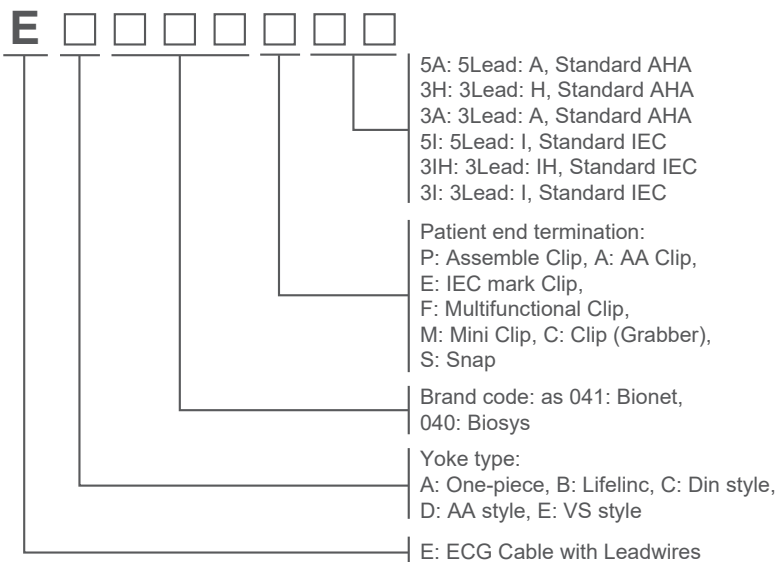

Product Features

1. For adult and pediatric patients;
2. Meeting the requirements of EC53;
3. Integrated design, convenient for use and maintenance;
4. Flexible and durable cables, enduring repeated cleaning and disinfection;
5. Outstanding shielding property and anti-interference performance, protecting ECG signal from being interfered;
6. The electrode connector has a clear color mark, which can quickly and easily connect the electrode position;
7. Latex free.

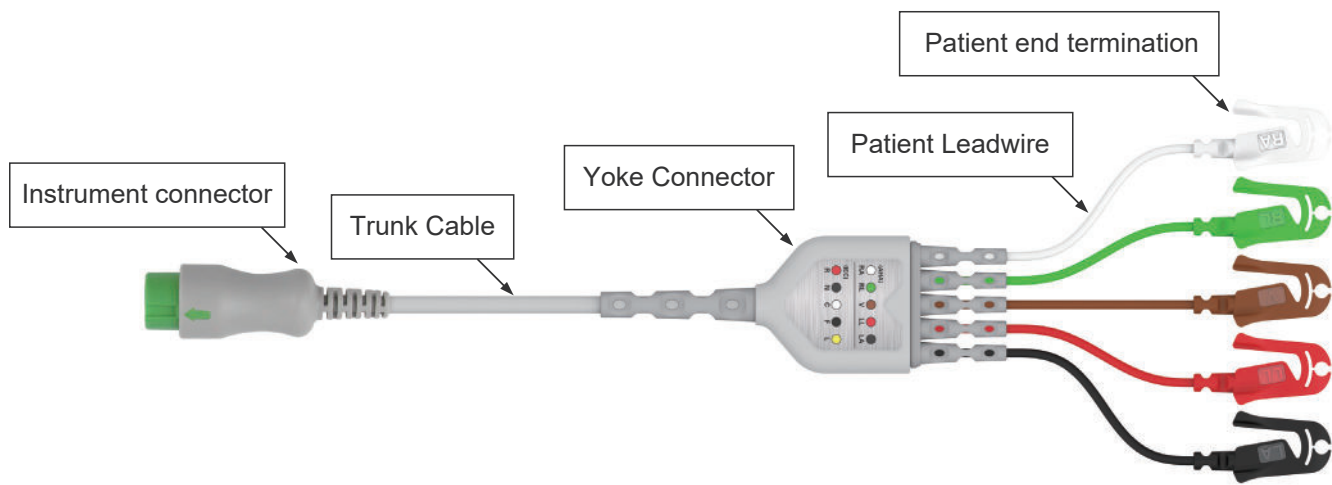

Instrument Connector

Lead Position Marked

Patient end connector

0007



1643



2818



0577



0020



0173

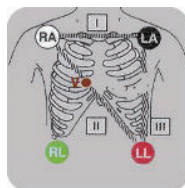

5 Lead: A
Standard AHA

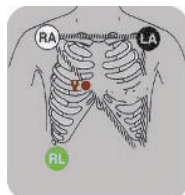

3 Lead: H
Standard AHA

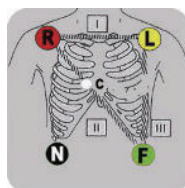

5 Lead: I
Standard IEC

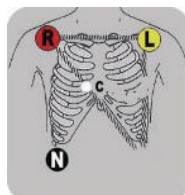

3 Lead: IH
Standard IEC



Standard Snap S



Type RL Grabber RL C



OEM Manufacturer & Models	Connector	OEM #	Descriptions	Order Code
Compatible AAMI				
AAMI: all Air Shields ATL BCI Colin Draeger Datascope Edan GE Healthcare Goldway Infinium Invivo Nihon Kohden Philips Spacelabs Medtronic Welch Allyn Zoll			Snap, TPU, 3 Ld, No Resistance, AHA	EA020S3A
			Snap, TPU, 3 Ld, No Resistance, IEC	EA020S3I
			Clip, TPU, 3 Ld, No Resistance, AHA	EA020C3A
			Clip, TPU, 3 Ld, No Resistance, IEC	EA020C3I
			Snap, TPU, 5 Ld, No Resistance, AHA	EA020S5A
			Snap, TPU, 5 Ld, No Resistance, IEC	EA020S5I
			Clip, TPU, 5 Ld, No Resistance, AHA	EA020C5A
			Clip, TPU, 5 Ld, No Resistance, IEC	EA020C5I
			Snap, TPU, 3 Ld, 1KΩ, AHA	EA021S3A
			Snap, TPU, 3 Ld, 1KΩ, IEC	EA021S3I
			Clip, TPU, 3 Ld, 1KΩ, AHA	EA021C3A
			Clip, TPU, 3 Ld, 1KΩ, IEC	EA021C3I
			Snap, TPU, 5 Ld, 1KΩ, AHA	EA021S5A
			Snap, TPU, 5 Ld, 1KΩ, IEC	EA021S5I
			Clip, TPU, 5 Ld, 1KΩ, AHA	EA021C5A
			Clip, TPU, 5 Ld, 1KΩ, IEC	EA021C5I
			Snap, PVC, 3 Ld, No Resistance, AHA	E0020J
			Snap, PVC, 3 Ld, No Resistance, IEC	E0020K
			Snap, PVC, 5 Ld, No Resistance, AHA	E0002J
			Snap, PVC, 5 Ld, No Resistance, IEC	E0002K
	Clip, PVC, 3 Ld, No Resistance, IEC	E0002W		
Compatible Bexen				
Reanibex 700			Snap, 5-Lead, AHA, 1kΩ, 12ft(3.6m)	EA419S5A
			Snap, 5-Lead, IEC, 1kΩ, 12ft(3.6m)	EA419S5I
Compatible Bionet (Korea)				
BM3			Snap, TPU, 3 Ld, 1kΩ, AHA	EA041S3A
			Snap, TPU, 3 Ld, 1kΩ, IEC	EA041S3I
			Grabber, TPU, 3Ld, 1kΩ, AHA	EA041S5A
			Grabber, TPU, 3Ld, 1kΩ, IEC	EA041S5I



OEM Manufacturer & Models	Connector	OEM #	Descriptions	Order Code
Compatible Bionet (Korea)				
BM5 BM7			Snap, TPU, 3Ld, No Resistance, AHA	EA400S3A
			Snap, TPU, 3Ld, No Resistance, IEC	EA400S3I
			Grabber, TPU, 3Ld, No Resistance, AHA	EA400C3A
			Grabber, TPU, 3Ld, No Resistance, IEC	EA400C3I
			Snap, TPU, 5Ld, No Resistance, AHA	EA400S5A
			Snap, TPU, 5Ld, No Resistance, IEC	EA400S5I
			Grabber, TPU, 5Ld, No Resistance, AHA	EA400C5A
			Grabber, TPU, 5Ld, No Resistance, IEC	EA400C5I
BPM-103			Snap, TPU, 5 Ld, No Resistance, IEC	EA040S5I
Compatible Bruker (Odam)				
SM784 SM785			Clip, TPU, 3 Ld, No Resistance, IEC	EA017C3I
			Clip, TPU, 4 Ld, No Resistance, IEC	EA017C3IH
Compatible Biolight (China)				
Creative: PC9000S, PC9000, UP6000, Biolight: M12			Snap, TPU, 3 Ld, AHA	EA046S3A
			Snap, TPU, 5 Ld, AHA	EA046S5A
A2E/A3/A5/A6/A8 Q3/Q5/Q7 (Production Models before 2018)			Snap,TPU, 3Ld, 1KΩ, AHA	EA417S3A
			Snap,TPU, 3Ld, 1KΩ, IEC	EA417S3I
			Grabber, TPU, 3Ld, 1KΩ, AHA	EA417C3A
			Grabber, TPU, 3Ld, 1KΩ, IEC	EA417C3I
			Snap, TPU, 5Ld, 1KΩ, AHA	EA417S5A
			Snap, TPU, 5Ld, 1KΩ, IEC	EA417S5I
			Grabber, TPU, 5Ld, 1KΩ, AHA	EA417C5A
			Grabber, TPU, 5Ld, 1KΩ, IEC	EA417C5I
Compatible Colin (Omron), Also See AAMI				
BP88S			Clip, TPU, 3 Ld, No Resistance, IEC	EA061C3I
Compatible Corpuls				
Corpuls 08/16, 0816M			Clip, TPU, 4 Ld, 1KΩ, IEC	EA076C3IH



	Connector	OEM #	Descriptions	Order Code
Compatible Comen (China)				
COMEN: C20, C21, C30, C50, C70, C90, C100, C100A, NC3, NC5, NC8, NC10, NC12, NC19		040-000320-00(AHA)	Snap, TPU, 3Ld, 1kΩ, AHA	EA414S3A
			Snap, TPU, 3Ld, 1kΩ, IEC	EA414S3I
		040-000368-00(AHA)	Grabber, TPU, 3Ld, 1kΩ, AHA	EA414C3A
			Grabber, TPU, 3Ld, 1kΩ, IEC	EA414C3I
		040-000321-00(AHA)	Snap, TPU, 5Ld, 1kΩ, AHA	EA414S5A
			Snap, TPU, 5Ld, 1kΩ, IEC	EA414S5I
		040-000369-00(AHA)	Grabber, TPU, 5Ld, 1kΩ, AHA	EA414C5A
			Grabber, TPU, 5Ld, 1kΩ, IEC	EA414C5I
Compatible Creative (China), See Biolight/Air Shields				
Compatible Drager/Siemens				
Drager UM1/3/3.1, RM1, PM8010, PM8014, Babyguard 8000, Cato, Babylog8000/8000 plus, PB8800 Serie 8000, Cicero, Parameterbox			Clip, TPU, 3 Ld, No Resistance, IEC	EA057C3I
Compatible Datex				
AS/3, CS/3, Cardiacap 1, Cardiacap 2, Cardiacap 5, Light Monitor, Satelliteplus			Clip, TPU, 3 Ld, No Resistance, IEC	EA010C3I
			Snap, TPU, 3 Ld, No Resistance, AHA	EA010S3A
			Clip, TPU, 5 Ld, No Resistance, IEC	EA010C5I
			Clip, TPU, 3 Ld, No Resistance, AHA	EA010C3A
			Snap, TPU, 5 Ld, No Resistance, IEC	EA010S5I
			Snap, TPU, 3 Ld, No Resistance, IEC	EA010S3I
			Snap, TPU, 5 Ld, No Resistance, AHA	EA010S5A
CS/3			Clip, TPU, 3 Ld, 4.7KΩ, IEC	EA091C3I
Compatible Fukuda Denshi				
DS5100E, DS5300W DS5400 Datascope: Expert MENNEN			Clip, TPU, 5 Ld, 1KΩ, IEC	EA068C5I
			Clip, TPU, 3 Ld, 1KΩ, IEC	EA068C3I
			Snap, TPU, 3 Ld, 1KΩ, IEC	EA068S3I
Compatible GE-Marquette				
Dash 1000/2500/5000, Dash PRO series, Eagle Systems, MAC-Lab, Solar series, Aestiva/5, Tram series, Responder 2000/3000, Corometrics 120, GE Vivid 7 Ultrasound, Datex Ohmeda E Prestin modules and Unity Systems			Snap, TPU, 3 Ld, No Resistance, AHA	EA007S3A
			Snap, TPU, 3 Ld, No Resistance, IEC	EA007S3I
			Clip, TPU, 3 Ld, No Resistance, AHA	EA007C3A
			Clip, TPU, 3 Ld, No Resistance, IEC	EA007C3I



	Connector	OEM #	Descriptions	Order Code
Compatible GE-Marquette				
Dash 1000/2500/5000, Dash PRO series, Eagle Systems, MAC-Lab, Solar series, Aestiva/5, Tram series, Responder 2000/3000, Corometrics 120, GE Vivid 7 Ultrasound, Datex Ohmeda E Prestin modules and Unity Systems			Clip, TPU, 5 Ld, No Resistance, AHA	EA007C5A
			Clip, TPU, 5 Ld, No Resistance, IEC	EA007C5I
			Snap, TPU, 5 Ld, No Resistance, AHA	EA007S5A
			Snap, TPU, 5 Ld, No Resistance, EC	EA007S5I
GE-MEDICAL PRO1000		See AAMI		
Compatible Hellige				
Hellige, Servomed 4, Generation, SCP 851, SCP 852, SCP 844, SCS 804, CardioServ, VICOM-sm			Clip, TPU, 3 Ld, No Resistance, IEC	EA011C3I
			Snap, TPU, 3 Ld, No Resistance, AHA	EA011S3A
			Clip, TPU, 5 Ld, No Resistance, AHA	EA011C5A
			Snap, TPU, 5 Ld, No Resistance, IEC	EA011S5I
Compatible Kontron				
7000, 7135, 7135B, 7141, 72107250, 7251, K2000, KAAT, Kolormon, Micromon, Minimon, Supermon, Vitalmon			Clip, TPU, 5 Ld, No Resistance, IEC	EA031C5I
			Clip, TPU, 3 Ld, No Resistance, IEC	EA031C3I
Compatible Mek (Korea)				
MP1000, MP600, MP500			Clip, TPU, 3 Ld, No Resistance, IEC	EA029C3I
Mek (Korea)(M160246)			Grabber, 5Ld, No Resistance, IEC	EA033C5I
Compatible M&B (China)				
			Snap, TPU, 3 Ld, No Resistance, AHA	EA072S3A
Compatible Medtronic				
Lifepak 12, 120, Lifepak 20			Snap, TPU, 5 Ld, 10KΩ, AHA	EA066S5A
			Snap, TPU, 5 Ld, 10KΩ, IEC	EA066S5I
			Snap, TPU, 3 Ld, 10KΩ, AHA	EA066S3A
			Snap, TPU, 3 Ld, 10KΩ, IEC	EA066S3I
			Clip, TPU, 3 Ld, 10KΩ, IEC	EA066C3I
PHYSIO-CONTROL: Lifepak 2, 3, 33, Scope Monitor II; SIEMENS: Porta Pak 500PB, Porta Pak 500PM			Snap, TPU, 3 Ld, No Resistance, AHA	EA067S3A



OEM Manufacturer & Models	Connector	OEM #	Descriptions	Order Code
Compatible Mindray (China)				
PM7000/8000/9000			Clip, TPU, 3 Ld, No Resistance, IEC	EA085C3I
			Snap, TPU, 5 Ld, No Resistance, AHA	EA085S5A
			Snap, TPU, 5 Ld, No Resistance, IEC	EA085S5I
			Clip, TPU, 5 Ld, No Resistance, IEC	EA085C5I
			Snap, TPU, 3 Ld, No Resistance, AHA	EA085S3A
			Snap, TPU, 3 Ld, No Resistance, IEC	EA085S3I
			Grabber, TPU, 3Ld, No Resistance, AHA	EA085C3A
			Grabber, TPU, 5Ld, No Resistance, AHA	EA085C5A
MEC1000, MEC1200			See AAMI	
BeneView (T5, T6, T8) iPM series			Clip, TPU, 3 Ld, 1KΩ, AHA	EA050C3A
			Clip, TPU, 3 Ld, 1KΩ, IEC	EA050C3I
			Snap, TPU, 5 Ld, 1KΩ, AHA	EA050S5A
			Snap, TPU, 5 Ld, 1KΩ, IEC	EA050S5I
			Snap, TPU, 3 Ld, 1KΩ, AHA	EA050S3A
			Snap, TPU, 3 Ld, 1KΩ, IEC	EA050S3I
			Clip, TPU, 5 Ld, 1KΩ, AHA	EA050C5A
			Clip, TPU, 5 Ld, 1KΩ, IEC	EA050C5I
PM5000/6000			Clip, TPU, 3 Ld, No Resistance, IEC	EA060C3I
			Snap, TPU, 3 Ld, No Resistance, AHA	EA060S3A
			Snap, TPU, 5 Ld, No Resistance, AHA	EA060S5A
			Snap, TPU, 5 Ld, No Resistance, IEC	EA060S5I
Compatible Nihon Kohden				
NIHON KOHDEN			Clip, TPU, 3 Ld, No Resistance, IEC	EA055C3A
			Clip, TPU, 3 Ld, No Resistance, IEC	EA055S3A
Compatible Philips				
Defibrillator, Agilent, Envisor, IntelliVue, MP20/30/50, IE33, IE33, 43100A, 43120A, 78352C, M1001A, M1165A, M1204A, Transport, M1722A/B, M2601A, M3000A, V24E, Agilent 50XM Fetal Monitor, Newtech NT3A			Snap, TPU, 5 Ld, 1KΩ, AHA	EA023S5A
			Snap, TPU, 5 Ld, 1KΩ, IEC	EA023S5I
			Snap, TPU, 3 Ld, 1KΩ, AHA	EA023S3A
			Snap, TPU, 3 Ld, 1KΩ, IEC	EA023S3I
			Clip, TPU, 3 Ld, 1KΩ, AHA	EA023C3A
			Clip, TPU, 3 Ld, 1KΩ, IEC	EA023C3I
			Clip, TPU, 3 Ld, 1KΩ, IEC	EA023A3I
			Clip, TPU, 5 Ld, 1KΩ, AHA	EA023C5A
			Clip, TPU, 5 Ld, 1KΩ, IEC	EA023C5I



OEM Manufacturer & Models	Connector	OEM #	Descriptions	Order Code
Compatible Philips				
Codemaster XL/100, 43100A, MC Defibrillator, 43200A Portable, M3500B, 77000AC, Sonos/AC/AR, 77025A, M1722A/B, Sonos 2000/2500, M2425A, M2475B			Clip, TPU, 5 Ld, 1KΩ, IEC	EA035C5I
			Snap, TPU, 3 Ld, 1KΩ, AHA	EA035S3A
			Snap, TPU, 3 Ld, 1KΩ, IEC	EA035S3I
			Clip, TPU, 3 Ld, 1KΩ, IEC	EA035C3I
			Snap, TPU, 5 Ld, 1KΩ, AHA	EA035S5A
			Snap, TPU, 5 Ld, 1KΩ, IEC	EA035S5I
			Clip, TPU, 6 Ld, 1KΩ, IEC	EA035C6I
Compatible Petas (Turkey)				
KMA160R, 165R, 260R, K-250, 300...			Clip, TPU, 4LD, No Resistance, IEC	EA063C3IH
Compatible Saadat				
			Clip, TPU, 3 Ld, 1KΩ, IEC	EA083C3I
			Clip, TPU, 5 Ld, 1KΩ, IEC	EA083C5I
			Snap, TPU, 3 Ld, 1KΩ, IEC	EA083S3I
			Snap, TPU, 3 Ld, 1KΩ, IEC	EA083P3I
Compatible Creative, Spurt, See Biolight				
Compatible S&W (Artema)				
8000, Diascope 1, Diascope 2, Diascope NT, Diascope 2010, AtheN/A			Clip, TPU, 3 Ld, No Resistance, IEC	EA018C3I
Compatible Schiller				
SHILLER ARGUS LCM+			Clip, TPU, 5 Ld, 1KΩ, IEC	EA082C5I
Compatible Spacelabs				
90496 Ultraview, 90369 Ultraview, 90367 Ultraview			Snap, TPU, 5 Ld, 1KΩ, AHA	EA009S5A
			Clip, TPU, 3 Ld, 1KΩ, AHA	EA009C3A
			Clip, TPU, 3 Ld, 1KΩ, IEC	EA009C3I
			Snap, TPU, 3 Ld, 1KΩ, IEC	EA009S3I
			Clip, TPU, 5 Ld, 1KΩ, AHA	EA009C5A
			Clip, TPU, 5 Ld, 1KΩ, IEC	EA009C5I
Compatible WelchAllyn, See AAMI				



4 ECG Trunk Cables

Type Designation

E □ □ □ □ □ □ □ □

Color coding:

3A/I: 3-Ld, AHA/IEC **5A/I:** 5-Ld, AHA/IEC
3I: 3-Ld, IEC **5I:** 5-Ld, IEC

Means "-" For example: ED008-3A

Length, as 040 indicated 40 in.

Yoke type: **A:** one-piece; **B:** Lifelinc, (LL);
C: Din style; **D:** AA style; **E:** VS style

E: Indicated patient monitor ECG cable and lead wires

Product Features

1. Easy to replace leadwires;
2. Meeting the requirements of EC53;
3. Flexible and durable cables, enduring repeated cleaning and disinfection;
4. Outstanding shielding property and anti-interference performance, protecting ECG signal from being interfered;
5. Excellent defibrillation-proof performance, protecting the equipment well;
6. ESU-proof, ensuring ECG signals not interfered during operation;
7. Latex free.



OEM Manufacturer & Models	Connector	Yoke (Leads Side)	OEM #	Order Code	Descriptions
Compatible Biolight (China)					
AnyView A2, AnyView A3, AnyView A5, AnyView A6, AnyView A8, AnyView Q3, AnyView Q5, AnyView Q7, AnyView V				EC417-3AI	3LD, 9ft (2.7m), AHA/IEC, No Resistance, fit for Din Style LeadWires
				EC417-5AI	5LD, 9ft (2.7m), AHA/IEC, No Resistance, fit for Din Style LeadWires
Compatible Bionet (Korea)					
BM3				EB041-3AI	3LD, 9ft (2.7m), AHA/IEC, 1KΩ, fit for LL Style LeadWires
BM5, BM7 NEW				ED400-3A	3LD, 9ft (2.7m), AHA, 1KΩ, fit for AA Style LeadWires
				ED400-5A	5LD, 9ft (2.7m), AHA, 1KΩ, fit for AA Style LeadWires
				ED400-5I	5LD, 9ft (2.7m), IEC, 1KΩ, fit for AA Style LeadWires
Compatible Colin (Omron)					
BP88S				EM061-5I	5Ld, 9ft (2.7m), IEC, No Resistance, fit for Colin LeadWires
Compatible Creative (China)					
PC9000S, PC9000, UP6000				EC046-3AI	3Ld, 9ft (2.7m), AHA/IEC, No Resistance, fit for Din style LeadWires
Compatible Comen (China)					
NEW Comen: C20, C21, C30, C50, C70, C90, C100, C100A, NC3, NC5, NC8, NC10, NC12, NC19			040-000413-00	EC414-3AI	3LD, 11.8ft (3.6m), AHA/IEC, No Resistance, fit for Comen LeadWires
				EC414-5AI	5LD, 11.8ft (3.6m), AHA/IEC, No Resistance, fit for Comen LeadWires
Compatible Drager/Siemens					
UM1/3/3.1, RM1, PM8010, PM8014, Babyguard8000, Cato, PB8800, Series 8000, Cicero, Parameterbox				EC057-3AI	3Ld, 9ft (2.7m), AHA/IEC, No Resistance, fit for Din style LeadWires



OEM Manufacturer & Models	Connector	Yoke (Leads Side)	OEM #	Order Code	Descriptions
Compatible Datascope					
2000, 2001, 2002, 2100, 2200, 3000, 3000A, Ballon Pump, M/D3 w/lead select, M/D3A, M/D4, Passport, Passport IL, Passport XG, Passport XL, Passport 2, Passport 2LT, Spectrum System 90, System 90T, System 96, System 97			0010-30-12377	EC002-3AI	3Ld, 9ft (2.7m), AHA/IEC, No Resistance, fit for Din style LeadWires
			0012-00-1255-01, 0010-30-42782	EC002-5AI	5Ld, 9ft (2.7m), AHA/IEC, No Resistance, fit for Din style LeadWires
Compatible Din Style Normal					
AAMI: ALL BCI Covidien Datex: Dräger: GE: 8700 Series Medtronic: Lifepak Mindray: Nihon Kohden Philips Spacelabs Welch Allyn Zoll			Covidien: 1340PS	EC020-3AI	3Ld, 9ft (2.7m), AHA/IEC, No Resistance, fit for Din style LeadWires
			Spacelabs: 012-0107-01	EC020-5AI	5Ld, 9ft (2.7m), AHA/IEC, No Resistance, fit for Din style LeadWires
			Covidien: 1340PS	EC021-3AI	3Ld, 9ft (2.7m), AHA/IEC, 1KΩ, fit for Din style LeadWires
			Datascope: 0012-00-0620-01	EC021-5AI	5Ld, 9ft (2.7m), AHA/IEC, 1KΩ, fit for Din style LeadWires
Compatible Datex					
AS/3, CS/3, S/5, Cardiocap 1, Cardiocap 2, Cardiocap 5, Light Monitor, Satliteplus			545307-HEL 545302-HEL	EB010-3AI	3Ld, 9ft (2.7m), AHA/IEC, No Resistance, fit for LL style LeadWires
			545303-HEL M1020563	EB010-5AI	5Ld, 9ft (2.7m), AHA/IEC, No Resistance, fit for LL style LeadWires
Datex-Ohmeda Patient monitor				EH010-3AI	3Ld, 9ft (2.7m), AHA/IEC, 4.7KΩ, fit for ASP style LeadWires
				EH010-5AI	5Ld, 9ft (2.7m), AHA/IEC, 4.7KΩ, fit for ASP style LeadWires



OEM Manufacturer & Models	Connector	Yoke (Leads Side)	OEM #	Order Code	Descriptions
Compatible Drager					
Drager Gamma/Gamma XL/ Gamma X XL Delta/Delta XL Kappa/Kappa XLT Vista/Vista XL			MS20094	EQ091-6AI	Multiparameter cable MultiMed® plus OR, for 6-lead ECG, resp., SpO2, and temp., 8.2ft (2.5m), 1KΩ resistance, AHA & IEC
			MS16256	EQ080-6AI	ECG extension Cables, 2M
Drager (Drager Infinity 6000 / 7000 / 9000 Gamma/Gamma XL/ Gamma X XL Delta/Delta XL Kappa/Kappa XLT Vista/Vista XL			3368391	EQ056-5AI	Multiparameter cable MultiMed® 5 Pod, for 5-lead ECG, resp., SpO2, and temp., 8.2ft (2.5m), 1KΩ resistanc, AHA & IEC
			5950196	EQ057-5AI	Multiparameter cable MultiMed® 5 Pod, for 5-lead ECG, resp., SpO2, and temp., 4.9ft (1.5m), 1KΩ resistanc, AHA & IEC
Compatible Emtel					
Emtel: Fx 2000				EC092-3AI	3Ld, 9ft (2.7m), AHA/IEC, 1KΩ, fit for Din style LeadWires
				EC094-3AI	3Ld, 9ft (2.7m), AHA/IEC, 1KΩ, fit for Din style LeadWires
Compatible Fukuda Denshi					
FUKUDA: Dynascope DS-7100				EJ032-5AI	5Ld, 9ft (2.7m), AHA/IEC, 10kΩ, fit for Euro style LeadWires
				NEW EJ032-3AI	3Ld, 9ft (2.7m), AHA/IEC, 10kΩ, fit for Euro style LeadWires
FUKUDA				NEW EC401-3I	3Ld, 9.2ft (2.8m), IEC, No Resistance, fit for Euro style LeadWires
				NEW ED401-3A-U	3Ld, 9ft (2.7m), AHA, No Resistance, fit for Euro style LeadWires
				ED401-5A	5Ld, 9ft (2.7m), AHA, No Resistance, fit for Euro style LeadWires



OEM Manufacturer & Models	Connector	Yoke (Leads Side)	OEM #	Order Code	Descriptions
Compatible Fukuda Denshi					
				VJ032-EAI	87in. (2.2m), 10kΩ Res. + discharge, AAMI/IEC, Fit Euro type leadwires As EJ040S5A and VJ040S5A
Fukuda Denshi DYNASCOPE DS-8500 CIO-05CTP-10NU				VJ200-EAI	87in. (2.2m), No resistance, AHA/IEC, fit for Euro style Lead Wires. As EJ040S5A and VJ040S5A
Compatible Goldway (China)					
Goldway: UT4000 Series UT6000F, UT4000Fpro, UT4800				EB002-3AI	3Ld, 9ft (2.7m), No resistance, AHA/IEC, fit for LL style LeadWires
				EB002-5AI	5Ld, 9ft (2.7m), No resistance, AHA/IEC, fit for LL style LeadWires
Compatible GE					
Marquette: GEMS: Dash PRO Series, Eagle Systems, MAC-Lab, Solar, Tram Series, Unity Systems			2022948-001	EE007-5AI	5Ld, 9ft (2.7m), AHA/IEC, No resistance, fit for VS style LeadWires
			2106307-001	EE007-6AI	6Ld, 11.8ft (3.6m), AHA/IEC, No resistance, fit for VS style LeadWires
Marquette: Pro1000				EH021-3AI	3Ld, 9ft (2.7m), AHA/IEC, 1KΩ, fit for ASP style LeadWires
				EH021-5AI	5Ld, 9ft (2.7m), AHA/IEC, 1KΩ, fit for ASP style LeadWires
GE-Marquette: For GE Eagle, Solar, Dash, Tram, MAC-Lab Cath Lab System, Datex-Ohmeda S/5 FM			(AAMI: E9002ZH, 416035-001) (IEC: E9002ZJ, 416035-002)	VE006-BAI	2.2m, 1kΩ resistance, AAMI/IEC fit for Multi-link (VS) style Lead Wires AS EE051S5I and EW051S5I-G







OEM Manufacturer & Models	Connector	Yoke (Leads Side)	OEM #	Order Code	Descriptions
Compatible Hellige					
Cardioserv Eagle 1000/3000;				EE011-5AI	5Ld, 9ft (2.7m), AHA/IEC, 10KΩ, fit for VS style LeadWires
Hellige, Servomed 4 Generation, SCP 851, SCP 852, SCP 844, SCS 804, VICOM-sm;				EB011-5AI	5Ld, 9ft (2.7m), AHA/IEC, No resistance, fit for LL style LeadWires
Hellige, Servomed 4 Generation, SCP 851 SCP 852, SCP 844 SCS 804, CardioServ VICOM-sm;				EH011-3AI	3Ld, 9ft (2.7m), AHA/IEC, 1KΩ, fit for ASP style LeadWires
Compatible Huntleigh Healthcare					
UK MONITOR				EC047-3AI	3Ld, 9ft (2.7m), AHA/IEC, No resistance, fit for Din style LeadWires
Compatible Lifelinc (LL) Style Normal					
LIFE SCIENCE INSTRUMENTS (LSI): LS5, 261, MEDICAL DATA electronics (MDE): Escort 100, Escort 101, Escort 102, Escort 200, Escort 300, Prism, 360SL, 450SL, 521A, PortaPak 80, PortaPak 90, PortaPak 1000				EB020-3AI	3Ld, 9ft (2.7m), AHA/IEC, No resistance, fit for LL style LeadWires
				EB020-5AI	5Ld, 9ft (2.7m), AHA/IEC, No resistance, fit for LL style LeadWires
Compatible Mindray (China)					
Mindray: PM7000/8000/9000; Creative: UT4000				EJ085-3AI	3Ld, 9ft (2.7m), AHA/IEC, 1KΩ, fit for Euro style LeadWires
				EJ085-5AI	5Ld, 9ft (2.7m), AHA/IEC, 1KΩ, fit for Euro style LeadWires



OEM Manufacturer & Models	Connector	Yoke (Leads Side)	OEM #	Order Code	Descriptions
Compatible Mindray (China)					
PM-6000 after 2004			0010-30-12378	EJ021-3AI	3Ld, 9ft (2.7m), AHA/IEC, 1KΩ, fit for Euro style LeadWires
			0010-30-12257	EJ021-5AI	5Ld, 9ft (2.7m), AHA/IEC, 1KΩ, fit for Euro style LeadWires
PM6000, T8			0010-30-12379	EJ050-3AI	3Ld, 9ft (2.7m), AHA/IEC, 1KΩ, fit for Euro style LeadWires
			0010-30-12260	EJ050-5AI	5Ld, 9ft (2.7m), AHA/IEC, 1KΩ, fit for Euro style LeadWires
PM-6800, PM-6000 after 2004, BeneView (T5, T6, T8), iPM Series; (Beneheart D6, BeneView T1, T5, T8, DPM 6,7, iPM-9800, MEC 1000, MPM, Passport 12, Passport 8, PM5000, PM6000, T8)			0010-30-42724	EJ051-3AI	3Ld, 9ft (2.7m), AHA/IEC, 1KΩ, fit for Euro style LeadWires ESU-Proof
			0010-30-42723	EJ051-5AI	5Ld, 9ft (2.7m), AHA/IEC, 1KΩ, fit for Euro style LeadWires ESU-Proof
		0010-30-42719	EC050-3AI	3Ld, 9ft (2.7m), AHA/IEC, 1KΩ, fit for Din style LeadWires	
Datascope passport V, V12, V21			0012-00-1745-01	ER090-3AI	3Ld, 10.5ft (3.2m), AHA/IEC, 1KΩ, fit for Mindray 3 Leadwires
			0012-00-1745-01	ER090-5AI	5Ld, 10.5ft (3.2m), AHA/IEC, 1KΩ, fit for Mindray 5 Leadwires



OEM Manufacturer & Models	Connector	Yoke (Leads Side)	OEM #	Order Code	Descriptions
Compatible Mindray (China)					
PM-7000/PM-9000Super/ PM-9000Express (12 LEAD ECG MODULE), View Oem p/n:0010-30-42721 (AAMI) Oem p/n: DPM6, DPM7, Passport 12m, Passport 17m, T1			0010-30- 42721	VE020-BAI	2.2m, 1kΩ resistance, AAMI/IEC, fit for Multi-link(VS) style Lead Wires AS VE008BNI and VE008CNA
Compatible Nihon Kohden					
OEC-6102A (s/n<20156), OEC-6105A (s/n<20226), OEC-6120A/J/K BSM-7105K				EC037-3AI	3Ld, 9ft (2.7m), AHA/IEC, 1kΩ , fit for Din style LeadWires
			JC-005P	EN037-3I	3Ld, 9ft (2.7m), IEC, No resistance, fit for BR-019 LeadWires
BSM-2301, BSM-2353, BSM-5100, Multi-parameter bedside monitors BSM-73			JC-906P	EP055-6I	6Ld, 9ft (2.7m), IEC, No resistance, fit for BR-903P, BR-906P
				EC055-3AI	3-Ld,9ft (2.7m), No resistance,AHA/IEC, fit for Din Style LeadWires
OPV-1500 Lifescope N BSM-73			L060 JC-103T	EP080-3I	3Ld, 9ft (2.7m), IEC, 47KΩ, fit for BR-903P, BR-906P
BSM-7102A,OMP-7201C, OMP-7203C, TEC-5200A (s/n<20421)				EC038-3AI	3Ld, 9ft (2.7m), AHA/IEC, No resistance, fit for Din style LeadWires
				EN038-3I	3Ld, 9ft (2.7m), IEC, No resistance, fit for BR-019 LeadWires



OEM Manufacturer & Models	Connector	Yoke (Leads Side)	OEM #	Order Code	Descriptions
Compatible Philips					
8-Pin Connector: 78208A, 78210A, 78330A, 78331A, 78332A, 78333A, 78341A, 78342A, 78345A, 78346A, 78351T, 78352A, 78353A, 78354A, 78532A/B, 78534A/B/C, M1722A/B, M3500B			M1600A	ED035-5I	5Ld, 9ft (2.7m), IEC, 1KΩ, fit for AA style LeadWires
			M1610A	ED035-3A	3Ld, 9ft (2.7m), AHA, 1KΩ, fit for AA style LeadWires
			M1580A	ED035-3I	3Ld, 9ft (2.7m), IEC, 1KΩ, fit for AA style LeadWires
			M1590	ED036-3A	3Ld, 9ft (2.7m), AHA, 1KΩ, fit for AA style LeadWires
78834C 78850A			M1620A	ED036-3I	3Ld, 9ft (2.7m), IEC, 1KΩ, fit for AA style LeadWires
			M1663A, M1949A (2.7m), M3525A, 989803125831 (2.7m), 989803144791	VDG023-AAI	8.9ft (2.7m), AAMI/IEC, 1KΩ, fit for Philips style Lead Wires AS VDG040CNA or VDG040SNI
M3000A, M3001A, M1001A/B, M1002A/B, 78352C, 78354C			M1669A	EDG073-3AI	3Ld, 9ft (2.7m), IEC/AAMI, 1KΩ, fit for Philips LeadWires
			M1668A	EDG073-5AI	5Ld, 9ft (2.7m), IEC/AAMI, 1KΩ, fit for Philips LeadWires
			98980317 0171	EDG073-3AI-OR	3Ld, 9ft (2.7m), IEC/AAMI, 1KΩ, Used with EDG040C3A-OR/ EDG040C3I-OR
			98980317 0181	EDG073-5AI-OR	5Ld, 9ft (2.7m), IEC/AAMI, 1KΩ, Used with EDG040C5A-OR/ EDG040C5I-OR



OEM Manufacturer & Models	Connector	Yoke (Leads Side)	OEM #	Order Code	Descriptions
Compatible Philips					
78352C, 7834C, 78834C, M1001A/B, M1002A/B, M1722A/B, M1723A/B, M2475B, M3000A, M3001A, M4735A, VM4/V24			M1500A	ED023-3A	3Ld, 9ft (2.7m), AHA, 1KΩ, fit for AA style LeadWires
			M1510A	ED023-3I	3Ld, 9ft (2.7m), IEC, 1KΩ, fit for AA style LeadWires
			M1520A	ED023-5A	5Ld, 9ft (2.7m), AHA, 1KΩ, fit for AA style LeadWires
			M1530A	ED023-5I	5Ld, 9ft (2.7m), IEC, 1KΩ, fit for AA style LeadWires
Philips ECG Leadwires Set					
Patient Monitor				ED021-5AI	5Ld,9ft(2.7m),AHA/IEC, 1KΩ,fit for AA styleLeadWires
				ED021-3AI	3Ld, 9ft(2.7m), AHA/IEC, 1KΩ, fit for AA styleLeadWires
Compatible Spacelabs					
90496 Ultraview, 90369 Ultraview, 90367 Ultraview			IEC: 700-0008-07 AHA: 700-0008-06	EL009-5AI	5Ld, 9ft (2.7m), AHA/IEC, 1KΩ, fit for TRU-LINK LeadWires
				EE009-5AI	5Ld, 9ft (2.7m), AHA/IEC, 1KΩ, fit for VS style LeadWires
				EJ009-3AI	3Ld, 9ft (2.7m), AHA/IEC, 1KΩ, fit for Euro style LeadWires
				EJ009-5AI	5Ld, 9ft (2.7m), AHA/IEC, 1KΩ, fit for EURO style leads
TRU-LINK Accessories for 90496 Module			700-0008-01	VE027-BAI	2.2m, 1KΩ resistance, AAMI/IEC fit for Multi-link (VS) style Lead Wires AS VE008BNI, VE008CNA

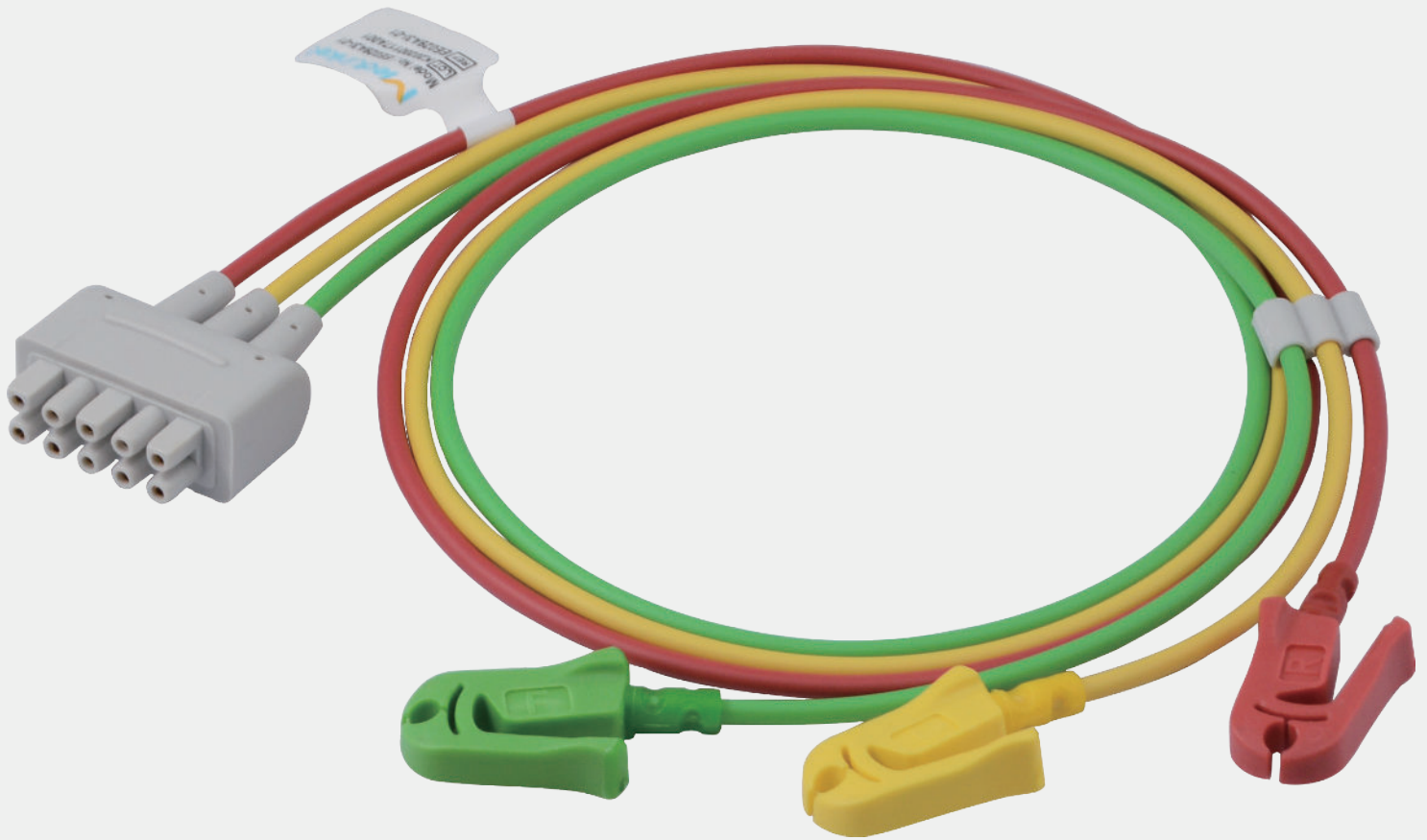

5 ECG Leadwires

Type Designation

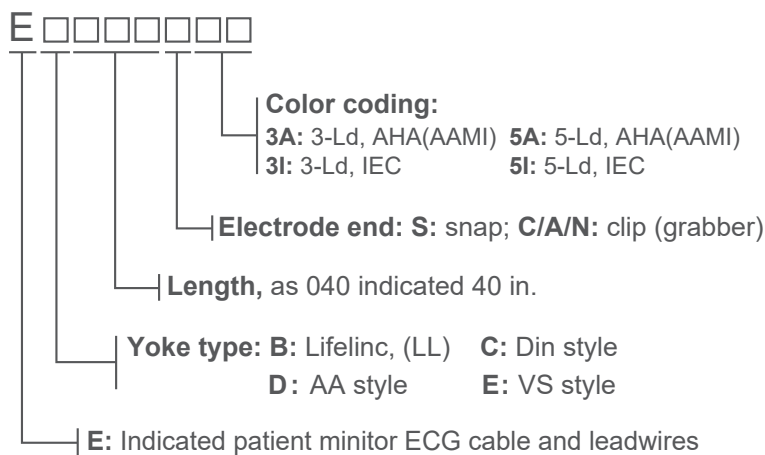

Product Features

1. For adult, pediatric and neonate patients;
2. Meeting the requirements of EC53;
3. Integrated two-color molding with flexibility, seamless connection and dustproof design;
4. Flexible and durable cables, enduring repeated cleaning and disinfection;
5. Outstanding shielding property and anti-interference performance, protecting ECG signal from being interfered;
6. Use different color cable to indicate the corresponding use lead wires position, easy to identify and operate;
7. Latex free.



Picture	OEM #	Descriptions	Order Code	
Din Type ECG Leadwires Set				
 <p>EC024N3A</p>		24in. (61cm), 3-Ld, Neonatal Grabber (Clip), No Resistance, AHA	EC024N3A	
		24in. (61cm), 3-Ld, Neonatal Grabber (Clip), No Resistance, IEC	EC024N3I	
		18in. (45cm), 3-Ld, Snap, No Resistance, AHA	EC018S3A	
		18in. (45cm), 3-Ld, Snap, No Resistance, IEC	EC018S3I	
		18in. (45cm), 3-Ld, Mini Grabber (Clip), No Resistance, AHA	EC018C3A	
		18in. (45cm), 3-Ld, Mini Grabber (Clip), No Resistance, IEC	EC018C3I	
		24in. (61cm), 3-Ld, Mini Snap, No Resistance, AHA	EC024S3A	
		24in. (61cm), 3-Ld, Mini Snap, No Resistance, IEC	EC024S3I	
		24in. (61cm), 3-Ld, Mini Grabber (Clip), No Resistance, AHA	EC024C3A	
		24in. (61cm), 3-Ld, Mini Grabber (Clip), No Resistance, IEC	EC024C3I	
	 <p>EC040C3A</p>		39in. (100cm), 3-Ld, Mini Snap, No Resistance, AHA	EC040S3A
			39in. (100cm), 3-Ld, Mini Snap, No Resistance, IEC	EC040S3I
		39in. (100cm), 3-Ld, Mini Grabber (Clip), No Resistance, AHA	EC040C3A	
		39in. (100cm), 3-Ld, Mini Grabber (Clip), No Resistance, IEC	EC040C3I	
		39in. (100cm), 3-Ld, Mini Grabber (Clip), No Resistance, AHA	EC040C3A	
		39in. (100cm), 3-Ld, Mini Grabber (Clip), No Resistance, IEC	EC040C3I	
Colin Type ECG Leadwires Set				
 <p>EM040S3I</p>		39in. (100cm), 3-Ld, Snap, No Resistance, AHA/IEC	EM040S3A	
		39in. (100cm), 3-Ld, Snap, No Resistance, AHA/IEC	EM040S3I	
		39in. (100cm), 3-Ld, Grabber (Clip), No Resistance, AHA/IEC	EM040C3A	
		39in. (100cm), 3-Ld, Grabber (Clip), No Resistance, AHA/IEC	EM040C3I	
		39in. (100cm), 5-Ld, Snap, No Resistance, AHA/IEC	EM040S5A	
		39in. (100cm), 5-Ld, Snap, No Resistance, AHA/IEC	EM040S5I	
		39in. (100cm), 5-Ld, Grabber (Clip), No Resistance, AHA/IEC	EM040C5A	
		39in. (100cm), 5-Ld, Grabber (Clip), No Resistance, AHA/IEC	EM040C5I	



Picture	OEM #	Descriptions	Order Code	
Conmed Type ECG Leadwires Set				
 <p>EG040S5A</p>		35in. (90cm), 3-Ld, Snap, No Resistance, AHA	EG040S3A	
		35in. (90cm), 3-Ld, Snap, No Resistance, IEC	EG040S3I	
		35in. (90cm), 3-Ld, Grabber (Clip), No Resistance, AHA	EG040C3A	
		35in. (90cm), 3-Ld, Grabber (Clip), No Resistance, IEC	EG040C3I	
		35in. (90cm), 5-Ld, Snap, No Resistance, AHA	EG040S5A	
		35in. (90cm), 5-Ld, Snap, No Resistance, IEC	EG040S5I	
		35in. (90cm), 5-Ld, Grabber (Clip), No Resistance, AHA	EG040C5A	
		35in. (90cm), 5-Ld, Grabber (Clip), No Resistance, IEC	EG040C5I	
Drager-Siemens Single-Pin Type ECG Leadwires Set				
 <p>EQ040S3I</p> <p>EQ040C3I</p>		35in. (90cm), 3-Ld, Snap, No Resistance, AHA	EQ040S3A	
		35in. (90cm), 3-Ld, Snap, No Resistance, IEC	EQ040S3I	
	MP03402/MP03422 MP03401/MP03421		35in. (90cm), 3-Ld, Grabber (Clip), No Resistance, AHA	EQ040C3A
			35in. (90cm), 3-Ld, Grabber (Clip), No Resistance, IEC	EQ040C3I
		35in. (90cm), 5-Ld, Snap, No Resistance, AHA	EQ040S5A	
		35in. (90cm), 5-Ld, Snap, No Resistance, IEC	EQ040S5I	
	MP03404/MP03424 MP03403/MP03423		35in. (90cm), 5-Ld, Grabber (Clip), No Resistance, AHA	EQ040C5A
			35in. (90cm), 5-Ld, Grabber (Clip), No Resistance, IEC	EQ040C5I
		35in. (90cm), 6-Ld, Snap, No Resistance, AHA	EQ040S6A	
		35in. (90cm), 6-Ld, Snap, No Resistance, IEC	EQ040S6I	
		35in. (90cm), 6-Ld, Grabber (Clip), No Resistance, AHA	EQ040C6A	
		35in. (90cm), 6-Ld, Grabber (Clip), No Resistance, IEC	EQ040C6I	
	MP03406/MP03426 MP03405/MP03425		OR 35in. (90cm), 3-Ld, Grabber (Clip), 10KΩ, AHA	EQ040C3A-OR
			OR 35in. (90cm), 3-Ld, Grabber (Clip), 10KΩ, IEC	EQ040C3I-OR
		36in(92cm), 5-Ld, Snap, No Resistance, AHA	EQ035S5A	
		36in(92cm), 5-Ld, Snap, No Resistance, IEC	EQ035S5I	
		36in(92cm), 6-Ld, Snap, No Resistance, AHA	EQ-096P6A	
		36in(92cm), 6-Ld, Snap, No Resistance, IEC	EQ-096P6I	



Picture	OEM #	Descriptions	Order Code
Drager-Siemens Dual-Pin Type ECG Leadwires Set			
 <p>EJ074C5A</p>		35in. (90cm), 3-Ld, Snap, No Resistance, AHA	EJ074S3A
		35in. (90cm), 3-Ld, Snap, No Resistance, IEC	EJ074S3I
	MP03412 MP03411	35in. (90cm), 3-Ld, Grabber (Clip), No Resistance, AHA	EJ074C3A
		35in. (90cm), 3-Ld, Grabber (Clip), No Resistance, IEC	EJ074C3I
		35in. (90cm), 5-Ld, Snap, No Resistance, AHA	EJ074S5A
		35in. (90cm), 5-Ld, Snap, No Resistance, IEC	EJ074S5I
	MP03414 MP03413	35in. (90cm), 5-Ld, Grabber (Clip), No Resistance, AHA	EJ074C5A
		35in. (90cm), 5-Ld, Grabber (Clip), No Resistance, IEC	EJ074C5I
		36in(0.9m), 3-Ld, Clip, No Resistance, AHA, Infant	EJB035N3A
		36in(0.9m), 3-Ld, Clip, No Resistance, IEC, Infant	EJB035N3I
GE Datex Ohmeda ASP Type ECG Leadwires Set			
 <p>EH040C3A</p>	545327-HEL(75cm) 107328(150cm)	39in. (100cm), 3-Ld, Snap, No Resistance, AHA	EH040S3A
		39in. (100cm), 3-Ld, Snap, No Resistance, IEC	EH040S3I
	545317-HEL(75cm) 8001958(150cm)	39in. (100cm), 3-Ld, Grabber (Clip), No Resistance, AHA	EH040C3A
		39in. (100cm), 3-Ld, Grabber (Clip), No Resistance, IEC	EH040C3I
	545317-HEL(75cm) 8001958(150cm)	24in. (61cm), 3-Ld, Grabber (Clip), No Resistance, AHA	EH024C3A
		24in. (61cm), 3-Ld, Grabber (Clip), No Resistance, IEC	EH024C3I
	545328	39in. (100cm), 5-Ld, Snap, No Resistance, AHA	EH040S5A
		39in. (100cm), 5-Ld, Snap, No Resistance, IEC	EH040S5I
	545318(Mixed) 8001959-HEL, 545326	39in. (100cm), 5-Ld, Grabber (Clip), No Resistance, AHA	EH040C5A
		39in. (100cm), 5-Ld, Grabber (Clip), No Resistance, IEC	EH040C5I
GE CARESCAPE ONE Mini ECG Lead Wires			
		29in.(74cm), 4-Ld, Grabber (Clip), No Resistance, AHA	EV029C4A
		29in.(74cm), 4-Ld, Grabber (Clip), No Resistance, IEC	EV029C4I
GE Multi-link type ECG Leadwires Set			
	2106394-003	51in. (130cm), 5-Ld, Non-Molded, Snap, Chest, No Resistance, AHA	EW051S5A
		51in. (130cm), 5-Ld, Non-Molded, Snap, Chest, No Resistance, IEC	EW051S5I
	2106394-003	51in. (130cm), 5-Ld, Non-Molded, Grabber (Clip), Chest, No Resistance, AHA	EW051C5A
		51in. (130cm), 5-Ld, Non-Molded, Grabber (Clip), Chest, No Resistance, IEC	EW051C5I



Picture	OEM #	Descriptions	Order Code	
GE Multi-link type ECG Leadwires Set				
<p>EE029C3A-G</p>		29in. (75cm), 3-Ld, Non-Molded, Snap, No Resistance, AHA	EE029S3A	
		29in. (75cm), 3-Ld, Non-Molded, Snap, No Resistance, IEC	EE029S3I	
		2106385-001	29in. (75cm), 3-Ld, Molded, Snap, No Resistance, AHA	EE029S3A-G
			29in. (75cm), 3-Ld, Molded, Snap, No Resistance, IEC	EE029S3I-G
			29in. (75cm), 3-Ld, Non-Molded, Grabber (Clip), No Resistance, AHA	EE029C3A
			29in. (75cm), 3-Ld, Non-Molded, Grabber (Clip), No Resistance, IEC	EE029C3I
	<p>EE029C3I-G</p>	411203-001 411203-003	29in. (75cm), 3-Ld, Molded, Grabber (Clip), No Resistance, AHA	EE029C3A-G
			29in. (75cm), 3-Ld, Molded, Grabber (Clip), No Resistance, IEC	EE029C3I-G
		2106381-001	29in. (75cm), 5-Ld, Non-Molded, Snap, No Resistance, AHA	EE029S5A
			29in. (75cm), 5-Ld, Non-Molded, Snap, No Resistance, IEC	EE029S5I
	<p>EE029S5A-G</p>	411202-001 411202-003	29in. (75cm), 5-Ld, Molded, Snap, No Resistance, AHA	EE029S5A-G
			29in. (75cm), 5-Ld, Molded, Snap, No Resistance, IEC	EE029S5I-G
	2106391-001	29in. (75cm), 5-Ld, Non-Molded, Grabber (Clip), No Resistance, AHA	EE029C5A	
		29in. (75cm), 5-Ld, Non-Molded, Grabber (Clip), No Resistance, IEC	EE029C5I	
	412681-001 412681-003	29in. (75cm), 5-Ld, Molded, Grabber (Clip), No Resistance, AHA	EE029C5A-G	
		29in. (75cm), 5-Ld, Molded, Grabber (Clip), No Resistance, IEC	EE029C5I-G	
	421930-001 421931-001	29in. (75cm), 6-Ld, Non-Molded, Snap, Chest, No Resistance, AHA	EE029S6A	
		29in. (75cm), 6-Ld, Non-Molded, Snap, Chest, No Resistance, IEC	EE029S6I	
	421932-001 421933-001	29in. (75cm), 6-Ld, Non-Molded, Grabber (Clip), Chest, No Resistance, AHA	EE029C6A	
		29in. (75cm), 6-Ld, Non-Molded, Grabber (Clip), Chest, No Resistance, IEC	EE029C6I	
	2106385-002	51in. (130cm), 3-Ld, Non-Molded, Snap, No Resistance, AHA	EE051S3A	
		51in. (130cm), 3-Ld, Non-Molded, Snap, No Resistance, IEC	EE051S3I	
	411203-002 411203-004	51in. (130cm), 3-Ld, Molded, Snap, No Resistance, AHA	EE051S3A-G	
		51in. (130cm), 3-Ld, Molded, Snap, No Resistance, IEC	EE051S3I-G	



Picture	OEM #	Descriptions	Order Code
GE Multi-link type ECG Leadwires Set			
<p>EE051S5A</p> <p>EE051C5A</p>		51in. (130cm), 3-Ld, Non-Molded, Grabber (Clip), No Resistance, AHA	EE051C3A
		51in. (130cm), 3-Ld, Non-Molded, Grabber (Clip), No Resistance, IEC	EE051C3I
	412682-002 412682-004	51in. (130cm), 3-Ld, Molded, Grabber (Clip), No Resistance, AHA	EE051C3A-G
		51in. (130cm), 3-Ld, Molded, Grabber (Clip), No Resistance, IEC	EE051C3I-G
	2106381-002	51in. (130cm), 5-Ld, Non-Molded, Snap, No Resistance, AHA	EE051S5A
		51in. (130cm), 5-Ld, Non-Molded, Snap, No Resistance, IEC	EE051S5I
	411202-002 411202-004	51in. (130cm), 5-Ld, Molded, Snap, No Resistance, AHA	EE051S5A-G
		51in. (130cm), 5-Ld, Molded, Snap, No Resistance, IEC	EE051S5I-G
	2106391-002	51in. (130cm), 5-Ld, Non-Molded, Grabber (Clip), No Resistance, AHA	EE051C5A
		51in. (130cm), 5-Ld, Non-Molded, Grabber (Clip), No Resistance, IEC	EE051C5I
	412681-002 412681-004	51in. (130cm), 5-Ld, Molded, Grabber (Clip), No Resistance, AHA	EE051C5A-G
		51in. (130cm), 5-Ld, Molded, Grabber (Clip), No Resistance, IEC	EE051C5I-G
	2106383-005	Mixed, 31.5 in/51.2in, 5-Ld, Molded, Snap, No Resistance, AHA/IEC	EE051S5A-GM
		Mixed, 31.5 in/51.2in, 5-Ld, Molded, Snap, No Resistance, AHA/IEC	EE051S5I-GM
	2106389-005	Mixed, 31.5 in/51.2in, 5-Ld, Molded, Grabber (Clip), No Resistance, AHA	EE051C5A-GM
		Mixed, 31.5 in/51.2in, 5-Ld, Molded, Grabber (Clip), No Resistance, IEC	EE051C5I-GM
	2106381-005	Mixed, 31.5 in/51.2in, 5-Ld, Non-Molded, Snap, No Resistance, AHA	EE051S5A-M
		Mixed, 31.5 in/51.2in, 5-Ld, Non-Molded, Snap, No Resistance, IEC	EE051S5I-M
	2106391-005	Mixed, 31.5 in/51.2in, 5-Ld, Non-Molded, Grabber (Clip), No Resistance, AHA	EE051C5A-M
		Mixed, 31.5 in/51.2in, 5-Ld, Non-Molded, Grabber (Clip), No Resistance, IEC	EE051C5I-M
		35in.(90cm), 3-Ld, Snap, No Resistance, AHA/IEC	EED051P3A
		35in.(90cm), 3-Ld, Snap, No Resistance, AHA/IEC	EED051P3I



Picture	OEM #	Descriptions	Order Code
GE VS type ECG Leadwires Set			
<p>EE035C5A-G</p>		36in(92cm), 5-Ld, Grabber(Clip), No Resistance, AHA	EE035C5A-G
		36in(92cm), 5-Ld, Grabber(Clip), No Resistance, IEC	EE035C5I-G
		36in(92cm), 3-Ld, Grabber(Clip), No Resistance, AHA	EE035C3A-G
		36in(92cm), 3-Ld, Grabber(Clip), No Resistance, IEC	EE035C3I-G
Mindray-Datascope ECG Leadwires Set			
<p>ER027C5I</p>	0012-00-1503-05	28in. (70cm), 3-Ld, Snap, No Resistance, AHA	ER027S3A
		28in. (70cm), 3-Ld, Snap, No Resistance, IEC	ER027S3I
	0012-00-1514-05 0012-00-1503-14	28in. (70cm), 3-Ld, Grabber (Clip), No Resistance, AHA	ER027C3A
		28in. (70cm), 3-Ld, Grabber (Clip), No Resistance, IEC	ER027C3I
<p>EJ075C5A</p>	0012-00-1503-01	28in. (70cm), 5-Ld, Snap, No Resistance, AHA	ER027S5A
		28in. (70cm), 5-Ld, Snap, No Resistance, IEC	ER027S5I
	0012-00-1514-02 0012-00-1503-14	28in. (70cm), 5-Ld, Grabber (Clip), No Resistance, IEC	ER027C5I
	0010-30-42734 0010-30-42733	36in. (90cm), 3-Ld, Euro, Snap, No Resistance, AHA	EJ075S3A
		36in. (90cm), 3-Ld, Euro, Snap, No Resistance, IEC	EJ075S3I
	0010-30-42726 0010-30-42725	36in. (90cm), 3-Ld, Euro, Grabber (Clip), No Resistance, AHA	EJ075C3A
		36in. (90cm), 3-Ld, Euro, Grabber (Clip), No Resistance, IEC	EJ075C3I
	0010-30-42735 0010-30-42736	36in. (90cm), 5-Ld, Euro, Snap, No Resistance, AHA	EJ075S5A
		36in. (90cm), 5-Ld, Euro, Snap, No Resistance, IEC	EJ075S5I
	0010-30-42727 0010-30-42728	36in. (90cm), 5-Ld, Euro, Grabber (Clip), No Resistance, AHA	EJ075C5A
	36in. (90cm), 5-Ld, Euro, Grabber (Clip), No Resistance, IEC	EJ075C5I	
		36in(0.9m), 3-Ld, Clip, No Resistance, AHA, Infant	EJA035N3A
		36in(0.9m), 3-Ld, Clip, No Resistance, IEC, Infant	EJA035N3I
Euro Type ECG Leadwires Set (Code Assemblable)			
<p>EJ024S5I</p>		24in. (61cm), 3-Ld, Snap, No Resistance, AHA	EJ024S3A
		24in. (61cm), 3-Ld, Snap, No Resistance, IEC	EJ024S3I
		24in. (61cm), 3-Ld, Grabber (Clip), No Resistance, AHA	EJ024C3A
		24in. (61cm), 3-Ld, Grabber (Clip), No Resistance, IEC	EJ024C3I
		24in. (61cm), 5-Ld, Snap, No Resistance, AHA	EJ024S5A
		24in. (61cm), 5-Ld, Snap, No Resistance, IEC	EJ024S5I
Euro Type ECG Leadwires Set (Code Assemblable)			
<p>EJ040C3I</p>		24in. (61cm), 5-Ld, Grabber (Clip), No Resistance, AHA	EJ024C5A
		24in. (61cm), 5-Ld, Grabber (Clip), No Resistance, IEC	EJ024C5I
		40in. (102cm), 3-Ld, Snap, No Resistance, AHA	EJ040S3A
		40in. (102cm), 3-Ld, Snap, No Resistance, IEC	EJ040S3I
		40in. (102cm), 3-Ld, Grabber (Clip), No Resistance, AHA	EJ040C3A
		40in. (102cm), 3-Ld, Grabber (Clip), No Resistance, IEC	EJ040C3I



Picture	OEM #	Descriptions	Order Code
Euro Type ECG Leadwires Set (Code Assemblable)			
 <p>EJ040S5I</p>		40in. (102cm), 5-Ld, Snap, No Resistance, AHA	EJ040S5A
		40in. (102cm), 5-Ld, Snap, No Resistance, IEC	EJ040S5I
		40in. (102cm), 5-Ld, Grabber (Clip), No Resistance, AHA	EJ040C5A
		40in. (102cm), 5-Ld, Grabber (Clip), No Resistance, IEC	EJ040C5I
Nihon Kohden Type ECG Leadwires Set			
 <p>EP035S3I</p> <p>EP035C3I</p> <p>EP035S6A</p> <p>EP035S6I</p> <p>EP035C6A</p> <p>EP035C6I</p> <p>EN032S3A</p> <p>EN032S3I</p> <p>EN032C3A</p> <p>EN032C3I</p> <p>EN032S5A</p> <p>EN032S5I</p> <p>EN032C5A</p> <p>EN032C5I</p>	BR-913PA BR-913P	35in. (90cm), 3-Ld, Snap, No Resistance, AHA	EP035S3A
		35in. (90cm), 3-Ld, Snap, No Resistance, IEC	EP035S3I
	BR903PA BR-903P	35in. (90cm), 3-Ld, Grabber (Clip), No Resistance, AHA	EN035C3A
		35in. (90cm), 3-Ld, Grabber (Clip), No Resistance, IEC	EP035C3I
	BR-916PA BR-916P	35in. (90cm), 6-Ld, Snap, No Resistance, AHA	EP035S6A
		35in. (90cm), 6-Ld, Snap, No Resistance, IEC	EP035S6I
	BR-906PA BR-906P	35in. (90cm), 6-Ld, Grabber (Clip), No Resistance, AHA	EP035C6A
		35in. (90cm), 6-Ld, Grabber (Clip), No Resistance, IEC	EP035C6I
	BR-019PA BR-019P	32in. (80cm), 3-Ld, Snap, No Resistance, AHA	EN032S3A
		32in. (80cm), 3-Ld, Snap, No Resistance, IEC	EN032S3I
	BR-018PA BR-018P	32in. (80cm), 3-Ld, Grabber (Clip), No Resistance, AHA	EN032C3A
		32in. (80cm), 3-Ld, Grabber (Clip), No Resistance, IEC	EN032C3I
	BR-021PA BR-021P	32in. (80cm), 5-Ld, Snap, No Resistance, AHA	EN032S5A
		32in. (80cm), 5-Ld, Snap, No Resistance, IEC	EN032S5I
	BR-020PA BR-020P	32in. (80cm), 5-Ld, Grabber (Clip), No Resistance, AHA	EN032C5A
		32in. (80cm), 5-Ld, Grabber (Clip), No Resistance, IEC	EN032C5I
Philips CBL Type ECG Leadwires Set			
 <p>EDG040C3I</p> <p>EDG040N5I</p>	M1673A	40in. (102cm), 3-Ld, Snap, No Resistance, AHA	EDG040S3A
		40in. (102cm), 3-Ld, Snap, No Resistance, IEC	EDG040S3I
	M1671A	40in. (102cm), 3-Ld, Grabber (Clip), No Resistance, AHA	EDG040C3A
		40in. (102cm), 3-Ld, Grabber (Clip), No Resistance, IEC	EDG040C3I
	M1644A	40in. (102cm), 5-Ld, Snap, No Resistance, AHA	EDG040S5A
		40in. (102cm), 5-Ld, Snap, No Resistance, IEC	EDG040S5I
	M1968A	40in. (102cm), 5-Ld, Grabber (Clip), No Resistance, AHA	EDG040C5A
		40in. (102cm), 5-Ld, Grabber (Clip), No Resistance, IEC	EDG040C5I
	M1672A	35in.(90cm), 3-Ld, Grabber(Clip), No Resistance, AHA	EDG040N3A
		35in.(90cm), 3-Ld, Grabber(Clip), No Resistance, IEC	EDG040N3I
	M1647A/989803145011	Reusable, 5 Leads, Mini Grabber clip, AHA, 36 Inches	EDG040N5A
	M1648A	Reusable, 5 Leads, Mini Grabber clip, IEC, 36 Inches	EDG040N5I
M1624A/989803144941	Reusable,3 Leads, Mini Grabber clip, AHA, 36 Inches	EDG040N3A	
M1626A/989803144951	Reusable,3 Leads, Mini Grabber clip, IEC, 36 Inches	EDG040N3I	



Picture	OEM #	Descriptions	Order Code	
Philips AA Type ECG Leadwires Set				
 <p>ED040C3I</p>	M1605A	40in. (102cm), 3-Ld, Snap, No Resistance, AHA	ED040S3A	
		40in. (102cm), 3-Ld, Snap, No Resistance, IEC	ED040S3I	
	M1603A	40in. (102cm), 3-Ld, Grabber (Clip), No Resistance, AHA	ED040C3A	
		40in. (102cm), 3-Ld, Grabber (Clip), No Resistance, IEC	ED040C3I	
	M1625A	39in/61in. (100cm/155cm), 5-Ld, Snap, No Resistance, AHA	ED040S5A	
		39in/61in. (100cm/155cm), 5-Ld, Snap, No Resistance, IEC	ED040S5I	
	M1623A	39in/61in. (100cm/155cm), 5-Ld, Grabber (Clip), No Resistance, AHA	ED040C5A	
		39in/61in. (100cm/155cm), 5-Ld, Grabber (Clip), No Resistance, IEC	ED040C5I	
		39in. (100cm), 3-Ld, Infant, Grabber (Clip), No Resistance, AHA	ED040N3A	
		39in. (100cm), 3-Ld, Infant, Grabber (Clip), No Resistance, IEC	ED040N3I	
	Philips Orange Leadwires Set For Operating Room (ESU Protection)			
	 <p>EDG040C5A-OR</p>	M1675A M1678A	35in. (90cm), 3-Ld, Grabber (Clip), 10KΩ, AHA	EDG040C3A-OR
35in. (90cm), 3-Ld, Grabber (Clip), 10KΩ, IEC			EDG040C3I-OR	
M1973A M1974A		36in/61in. (92cm/155cm), 5-Ld, Grabber (Clip), 10KΩ, AHA	EDG040C5A-OR	
		36in/61in. (92cm/155cm), 5-Ld, Grabber (Clip), 10KΩ, IEC	EDG040C5I-OR	
M1601A		OR 39in. (100cm), 3-Ld, Grabber (Clip), 10KΩ, AHA	ED040C3A-OR	
		OR 39in. (100cm), 3-Ld, Grabber (Clip), 10KΩ, IEC	ED040C3I-OR	
M1621A		OR 39in/61in. (100cm/155cm), 5-Ld, Grabber (Clip), 10KΩ, AHA	ED040C5A-OR	
		OR 39in/61in. (100cm/155cm), 5-Ld, Grabber (Clip), 10KΩ, IEC	ED040C5I-OR	
Spacelabs TRU-Link Type ECG Leadwires Set				
 <p>EL024S3A</p>		700-0007-00 700-0007-01	23in. (60cm), 3-Ld, Snap, No Resistance, AHA	EL024S3A
	23in. (60cm), 3-Ld, Snap, No Resistance, IEC		EL024S3I	
		23in. (60cm), 3-Ld, Mni Grabber (Clip), No Resistance, AHA	EL024M3A	
		23in. (60cm), 3-Ld, Mni Grabber (Clip), No Resistance, IEC	EL024M3I	
	700-0006-00 700-0006-01	23in. (60cm), 3-Ld, Grabber (Clip), No Resistance, AHA	EL024C3A	
		23in. (60cm), 3-Ld, Grabber (Clip), No Resistance, IEC	EL024C3I	
	700-0007-08 700-0007-09	23in. (60cm), 5-Ld, Snap, No Resistance, AHA	EL024S5A	
		23in. (60cm), 5-Ld, Snap, No Resistance, IEC	EL024S5I	
	700-0006-08 700-0006-09	23in. (60cm), 5-Ld, Grabber (Clip), No Resistance, AHA	EL024C5A	
		23in. (60cm), 5-Ld, Grabber (Clip), No Resistance, IEC	EL024C5I	







Picture	OEM #	Descriptions	Order Code
Spacelabs TRU-Link Type ECG Leadwires Set			
<p>EL040S3I</p> <p>EL040C5I</p>	700-0007-02 700-0007-03	39in. (100cm), 3-Ld, Snap, No Resistance, AHA	EL040S3A
		39in. (100cm), 3-Ld, Snap, No Resistance, IEC	EL040S3I
	700-0006-02 700-0006-03	39in. (100cm), 3-Ld, Grabber (Clip), No Resistance, AHA	EL040C3A
		39in. (100cm), 3-Ld, Grabber (Clip), No Resistance, IEC	EL040C3I
		39in. (100cm), 5-Ld, Snap, No Resistance, AHA	EL040S5A
		39in. (100cm), 5-Ld, Snap, No Resistance, IEC	EL040S5I
	700-0006-10 700-0006-11	39in. (100cm), 5-Ld, Grabber (Clip), No Resistance, AHA	EL040C5A
		39in. (100cm), 5-Ld, Grabber (Clip), No Resistance, IEC	EL040C5I
Spacelabs LL Type ECG Leadwires Set			
<p>EB024S3A</p> <p>EB040C3I</p> <p>EB040S5A</p>	012-0418-00 012-0519-00	24in. (61cm), 3-Ld, Snap, No Resistance, AHA	EB024S3A
		24in. (61cm), 3-Ld, Snap, No Resistance, IEC	EB024S3I
	012-0417-00 012-0518-00	24in. (61cm), 3-Ld, Grabber (Clip), No Resistance, AHA	EB024C3A
		24in. (61cm), 3-Ld, Grabber (Clip), No Resistance, IEC	EB024C3I
	012-0416-00 012-0517-00	24in. (61cm), 5-Ld, Snap, No Resistance, AHA	EB024S5A
		24in. (61cm), 5-Ld, Snap, No Resistance, IEC	EB024S5I
		24in. (61cm), 5-Ld, Grabber (Clip), No Resistance, AHA	EB024C5A
		24in. (61cm), 5-Ld, Grabber (Clip), No Resistance, IEC	EB024C5I
	012-0464-00 012-0518-00	35in. (90cm), 3-Ld, Snap, No Resistance, AHA	EB040S3A
		35in. (90cm), 3-Ld, Snap, No Resistance, IEC	EB040S3I
	012-0465-00 012-0566-00	35in. (90cm), 3-Ld, Grabber (Clip), No Resistance, AHA	EB040C3A
		35in. (90cm), 3-Ld, Grabber (Clip), No Resistance, IEC	EB040C3I
012-0419-00 012-0520-00	35in. (90cm), 5-Ld, Snap, No Resistance, AHA	EB040S5A	
	35in. (90cm), 5-Ld, Snap, No Resistance, IEC	EB040S5I	
012-0466-00 012-0567-00	35in. (90cm), 5-Ld, Grabber (Clip), No Resistance, AHA	EB040C5A	
	35in. (90cm), 5-Ld, Grabber (Clip), No Resistance, IEC	EB040C5I	
LM Type ECG Leadwires Set			
<p>EZ040S5A</p>		40in. (102cm), 3-Ld, Snap, No Resistance, AHA	EZ040S3A
		40in. (102cm), 3-Ld, Snap, No Resistance, IEC	EZ040S3I
		40in. (102cm), 3-Ld, Grabber (Clip), No Resistance, AHA	EZ040C3A
		40in. (102cm), 3-Ld, Grabber (Clip), No Resistance, IEC	EZ040C3I
		40in. (102cm), 5-Ld, Snap, No Resistance, AHA	EZ040S5A
		40in. (102cm), 5-Ld, Snap, No Resistance, IEC	EZ040S5I
		40in. (102cm), 5-Ld, Grabber (Clip), No Resistance, AHA	EZ040C5A
		40in. (102cm), 5-Ld, Grabber (Clip), No Resistance, IEC	EZ040C5I









6 ECG Telemetry Leadwires







Product Features

Photo	Feature	Advantage
	Spring-loaded gold-plated connector	Safe and reliable connection.
	Fully Shielded Leadwires Design	Reduces the risk of Electromagnetic Interference (EMI).
	Peelable Ribbon Cable Design	Prevents lead wire entanglement and can be customized to fit any patient's body size.
	Side button and visual connection design	(1) Provide clinicians with a locking and visualization mechanism to achieve faster, efficient and firm connections; (2) Clinically proven to reduce the risk of "leads off" false alarms.
	Easy to used electrode colors Lightweight smooth design	(1) Easy and quick lead placement; (2) Increase patient comfort.



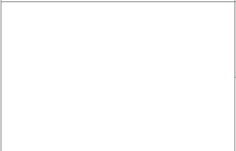





Compatible Models	Product Guide	OEM #	Lead #	Descriptions	Order Code
Compatible GE Healthcare					
GE Healthcare Apex, Apex S, ApexPro Telemetry		421930-001	6	Multi-Link Leadwires Set, Snap, AHA, 36 in. (92cm)	EE029S6A
		421931-001	6	Multi-Link Leadwires Set, Snap, IEC, 36 in. (92cm)	EE029S6I
		421932-001	6	Multi-Link Leadwires Set, Grabber, AHA, 36 in. (92cm)	EE029C6A
		421933-001	6	Multi-Link Leadwires Set, Grabber, IEC, 36 in. (92cm)	EE029C6I-G
Compatible Mindray (China)					
Mindray TMS-6016, TEL-100		115-004872-00	3	Telemetry ECG Leadwires, Grabber, IEC, 31 in. (80cm)	HA052C3I
		115-004871-00	3	Telemetry ECG Leadwires, Grabber, AHA, 31 in. (80cm)	HA052C3A
		115-004868-00	3	Telemetry ECG Leadwires, Snap, IEC, 31 in. (80cm)	HA052S3I
		115-004867-00	3	Telemetry ECG Leadwires, Snap, AHA, 31 in. (80cm)	HA052S3A
		115-004874-00	5	Telemetry ECG Leadwires, Grabber, IEC, 31 in. (80cm)	HA052C5I
		115-004873-00	5	Telemetry ECG Leadwires, Grabber, AHA, 31 in. (80cm)	HA052C5A
		115-004870-00	5	Telemetry ECG Leadwires, Snap, IEC, 31 in. (80cm)	HA052S5I
		115-004869-00	5	Telemetry ECG Leadwires, Snap, AHA, 31 in. (80cm)	HA052S5A
Mindray Benevision Telemetry Transmitter TD60, TM-80		009-004769-00	3	Euro style ECG Leadwires, Snap, IEC, 36 in. (92cm), TPU, reusable	ER036S3I
		009-004775-00	3	Euro style ECG Leadwires, Grabber, IEC, 36 in. (92cm), TPU, reusable	ER036C3I
		009-004785-00	5	Telemetry ECG Leadwires, Snap, IEC, 36 in. (92cm), TPU, reusable	ER036S5I
		009-004789-00	5	Telemetry ECG Leadwires, Grabber, IEC, 36 in. (92cm), TPU, reusable	ER036C5I
		009-004797-00	6	Telemetry ECG Leadwires, Snap, IEC, 36 in. (92cm), TPU, reusable	ER036S6I
		009-004801-00	6	Telemetry ECG Leadwires, Grabber, IEC, 36 in. (92cm), TPU, reusable	ER036C6I
		009-004780-00	3	Telemetry ECG Leadwires, Snap, IEC, 36 in. (92cm), single-patient	ERD036S3I
		009-004792-00	5	Telemetry ECG Leadwires, Snap, IEC, 36 in. (92cm), single-patient	ERD036S5I
			3	AHA, Snap, 40in.(100cm), single-patient	ERD036P3A









Compatible Models	Productor Guide	OEM #	Lead #	Descriptions	Order Code
Compatible Philips					
Philips IntelliVue 862108, M2600B, M2601B Viridia, M4840A, M4841A	 HF040A5A	989803173141	3	Grabber and shower shield, AHA, 40 in. (92cm), Single patient use	HF040A3A
		989803173151	5	Grabber and shower shield, AHA, 40 in. (92cm), Single patient use	HF040A5A
	 HF040S3A	989803151981	3	Grabber and shower shield, IEC, 40 in. (92cm), Reusable	HF040A3I
		989803151991	3	Snap and shower shield, AHA, 40 in. (92cm), Reusable	HF040S3A
		989803152001	3	Snap and shower shield, IEC, 40 in. (92cm), Reusable	HF040S3I
	 HF040A5I	989803152071	5	Snap and shower shield, AHA, 40 in. (92cm), Reusable	HF040S5A
		989803152061	5	Grabber and shower shield, IEC, 40 in. (92cm), Reusable	HF040A5I
		989803152081	5	Snap and shower shield, IEC, 40 in. (92cm), Reusable	HF040S5I
			5	Grabber and shower shield, AHA, 51in.(130cm), Reusable	HF050C5A
			5	Grabber and shower shield, IEC 51in.(130cm), Reusable	HF050C5I
			5	Grabber and shower shield, AHA IEC, 51in.(130cm), Reusable	HF050S5A
			5	Snap and shower shield, IEC, 40 in. (92cm), Reusable	HF050S5I
		5	Telemetry ECG Leadwires, AHA, Snap, 40in.(100cm), single-patient	HFD040P5A	
		5	Telemetry ECG Leadwires, IEC, Snap, 40in.(100cm), single-patient	HFD040P5I	
	Philips IntelliVue MX40 ECG Only (Reusable)	 ET035C3I	989803171901	3	Grabbers, IEC, 35in. (90cm), TPU
989803171801			3	Grabbers, AHA, 35in. (90cm), TPU	ET035C3A
 ET035S5A		989803171931	5	Grabbers, IEC, 35in. (90cm), TPU	ET035C5I
		989803171831	5	Grabbers, AHA, 35in. (90cm), TPU	ET035C5A
		989803171821	5	Snaps, AHA, 35in. (90cm), TPU	ET035S5A
 ET035C6I		989803171961	6	Grabbers, IEC, 35in. (90cm), TPU	ET035C6I
		989803171861	6	Grabbers, AHA, 35in. (90cm), TPU	ET035C6A



Compatible Models	Product Guide	OEM #	Lead #	Descriptions	Order Code
Compatible Philips					
Philips IntelliVue MX40 ECG Only (Reusable)	 ET035S5A-S		3	Snap, AHA, 35in.(90cm)	ET035S3A
			3	Snap, IEC, 35in.(90cm)	ET035S3I
			5	Snap, IEC, 35in.(90cm)	ET035S5I
			5	Grabber(Clip), AHA	ET035S5A-S
			5	Grabber(Clip), IEC	ET035C5A-S
			5	Grabber(Clip), AHA	ET035S5I-S
			3	Grabber(Clip), IEC	ET035S3I-S
			5	Snap, AHA, 35in.(90cm), PVC	ETD035P5A
	5	Snap, IEC, 35in.(90cm), PVC	ETD035P5I		
Philips IntelliVue MX40 ECG+SPO2 (Reusable)	 ET035C3I-S	989803171911	3	Grabbers, IEC, 35in. (90cm), TPU	ET035C3I-S
		989803171811	3	Grabbers, AHA, 35in. (90cm), TPU	ET035C3A-S
	 ET035S5A-S	989803171951	5	Grabbers, IEC, 35in. (90cm), TPU	ET035C5I-S
		989803171841	5	Snaps, AHA, 35in. (90cm), TPU	ET035S5A-S
		989803171851	5	Grabbers, AHA, 35in. (90cm), TPU	ET035C5A-S
			5	Snap,IEC, 35in.(90cm),TPU	ET035S5I-S
			3	Snap,IEC, 35in.(90cm),TPU	ET035S3I-S
			3	Snap,IEC, 35in.(90cm),TPU	ET035S3I-S
 ET035C6I-S	989803171971	6	Grabbers, IEC, 35in. (90cm), TPU	ET035C6I-S	
	989803171871	6	Grabbers, AHA, 35in. (90cm), TPU	ET035C6A-S	
Philips IntelliVue MX40 ECG Only (Single patient)	 ETD035S3A		3	Snap, AHA, 35in. (90cm), PVC	ETD035S3A
			3	Snap, IEC, 35in. (90cm), PVC	ETD035S3I
	 ETD035S5A		5	Snap, AHA, 35in. (90cm), PVC	ETD035S5A
			5	Snap, IEC, 35in. (90cm), PVC	ETD035S5I
	 ETD035C5A	989803172031	5	Grabbers, AHA, 35in. (90cm), PVC	ETD035C5A
		989803172131	5	Grabbers, IEC, 35in. (90cm), PVC	ETD035C5I



Compatible Models	Product Guide	OEM #	Lead #	Descriptions	Order Code
Compatible Philips					
Philips IntelliVue MX40 ECG Only (Single patient)			6	Grabbers, AHA, 35in. (90cm), PVC	ETD035C6A
			6	Grabbers, IEC, 35in. (90cm), PVC	ETD035C6I
			3	Snap, IEC, 35in. (90cm), TPU	ET035S3I
			5	Grabber, AHA/IEC, 50in. (1.27m), PVC	ET050C5A
			5	Grabber, AHA/IEC, 50in. (1.27m), PVC	ET050C5I
Philips IntelliVue MX40 ECG+SPO2 (Single patient)			3	Snap, AHA, 35in. (90cm), PVC	ETD035S3A-S
			3	Snap, IEC, 35in. (90cm), PVC	ETD035S3I-S
			5	Snap, AHA, 35in. (90cm), PVC	ETD035S5A-S
			5	Snap, IEC, 35in. (90cm), PVC	ETD035S5I-S
			5	Grabbers, AHA, 35in. (90cm), PVC	ETD035C5A-S
Philips IntelliVue MX40 ECG+SPO2 (Single patient)		989803172051	5	Grabbers, AHA, 35in. (90cm), PVC	ETD035C5A-S
		989803172151	5	Grabbers, IEC, 35in. (90cm), PVC	ETD035C5I-S
			6	Snap, AHA, 35in. (90cm), PVC	ETD035S6A-S
			6	Snap, IEC, 35in. (90cm), PVC	ETD035S6I-S



7 Holter Recorder ECG Cables with Leads

Compliance with

ANSI/AAMI EC53
IEC 60601-1
ISO 10993-1
ISO 10993-5
ISO 10993-10

Quality Management System

ISO13485: 2016
QSR820

CONTENTS ▶▶▶

Direct-Connect (one-piece) Holter ECG Cables	111	▶
Holter ECG Trunk Cables	115	▶
ECG Leadwires	116	▶

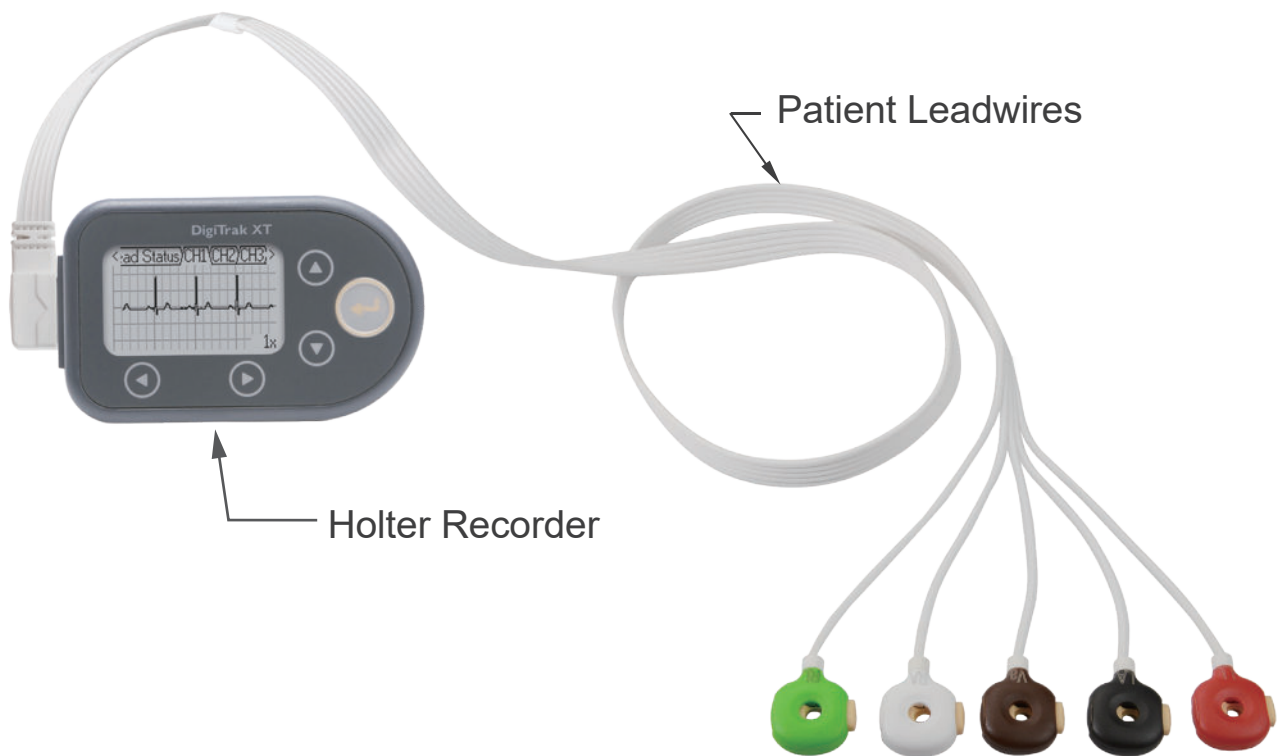

One-piece ECG



ECG Trunk Cables

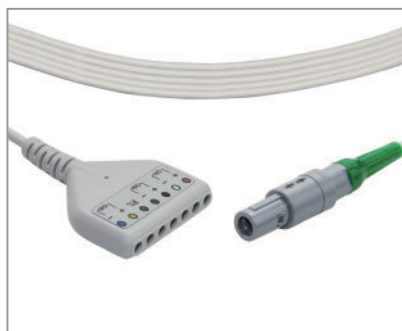

ECG Leadwires





Direct-Connect (one-piece) Holter ECG Cables

Type Designation

H □ □ □ □ □ □ □ □

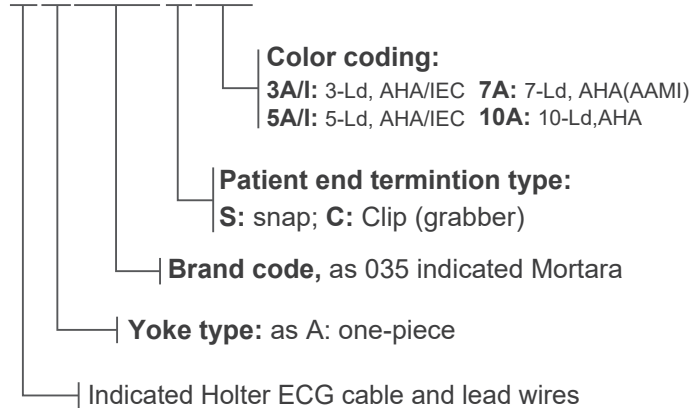

Product Features

1. Trunk Cables fully shielded, Low noise signal transfer;
2. Lighter weight and softer lead wire;
3. Fully compatible with OEM technology;
4. Latex free;
5. Good biocompatibility, free from biological hazard to skin.



Compatible Models	Product Picture	OEM #	Order Code	Descriptions
Compatible Biomedical Instruments (BI)/Brentwood				
Biomedical Instruments			HA055S7A	One-piece Holter ECG Cables, 18in. (45cm), 7-Ld, AHA, Snap
Compatible Creative (China)				
PC-80 Easy ECG Monitor, 2.5mm jack plug			HA022S3A	One-piece Holter ECG Cables, 18in. (45cm), 3-Ld, AHA, Snap
Compatible Fukuda Denshi				
		CMF-86C	HA057C4A	One-piece Holter ECG Cables, 31 in. (80cm), 4-Ld, AHA, Grabber
			NEW HA057C4I	One-piece Holter ECG Cables, 31 in. (80cm), 4-Ld, IEC, Grabber
Compatible Landcom, Also See Meigaoyi				
Visual Stethoscope			HA020C3I	One-piece Holter ECG Cables, 40 in. (102cm), 3-Ld, IEC, Grabber
MGY-M1			HA020S3I	One-piece Holter ECG Cables, 40 in. (102cm), 3-Ld, IEC, Snap
Compatible Meigaoyi				
ECGLAB TDA3.0			HA046S5A	One-piece Holter ECG Cables, 40 in. (102cm), 5-Ld, AHA, Snap
Compatible Mortara				
Mortara: H12/H12+, X12/X12+		9293-017-50	HA035S10I	One-piece Holter ECG Cables, 40 in. (102cm), 10-Ld, IEC, Snap



Compatible Models	Product Picture	OEM #	Order Code	Descriptions
Compatible GE-Marquette/Rozinn				
GE, Marquette: 8000, 8200, 8500, Rozinn SEER Holter Recorder model: 151			HA021S3A	One-piece Holter ECG Cables, 28 in. (70cm), 3-Ld, AHA, Snap
Compatible GE Healthcare				
SEER Light		2008594-001	HA053S5A	One-piece Holter ECG Cables, 55 in. (1.4M), 5-Ld, AHA, Snap
		2008594-002	HA053S7A	One-piece Holter ECG Cables, 55 in. (1.4M), 7-Ld, AHA, Snap
		2008594-004	HA053S7I	One-piece Holter ECG Cables, 55 in. (1.4M), 7-Ld, IEC, Snap
		2008594-002	HA130S7A	One-piece Holter ECG Cables, 55 in. (0.65M), 7-Ld, AHA, Snap
Compatible M&B (China)				
GE, Marquette: 8000, 8200, 8500 Rozinn SEER Holter Recorder model: 151			HA132S5A-C	One-piece Holter ECG Cables, 39 in. (1M), 5-Ld, AHA, Snap
Compatible MBELEC				
CD2000-1800			HA052S3A	One-piece Holter ECG Cables, 28 in. (70cm), 3-Ld, AHA, Snap
Compatible PI				
			HA048S4I	One-piece Holter ECG Cables, 40 in. (102cm), 4-Ld, IEC, Snap
			HA048S6I	One-piece Holter ECG Cables, 40 in. (102cm), 6-Ld, IEC, Snap



Compatible Models	Product Picture	OEM #	Order Code	Descriptions
Compatible Philips				
Zymed DigiTrak-Plus		M4725A, 350-0173-03	HA056S5A	Reusable One-piece Holter ECG Cables, 35 in. (0.9M), 5-Ld, AHA, Snap
			HA056S5I	Reusable One-piece Holter ECG Cables, 35 in. (0.9M), 5-Ld, IEC, Snap
Zymed DigiTrak XT		989803157 491	HA062P5A	Disposable One-piece Holter ECG Cables, 35 in. (0.9M), 5-Ld, AHA, Snap
			HA062P5I	Disposable One-piece Holter ECG Cables, 35 in. (0.9M), 5-Ld, IEC, Snap
Compatible Jincomed				
 MIC-12H Series MIC-3H Series			HA133S10A	One-piece Holter ECG Cables, 11pin, 10-Ld, AHA, Snap, 43in. (1.1M)
			HA133S10I	One-piece Holter ECG Cables, 11pin, 10-Ld, IEC, Snap, 43in. (1.1M)
Compatible Welch Allyn				
 Welch Allyn SE-PRO-600 PRO ECG recorder module		SE-PC-IEC-PUSH	HA135S10I	14pin, 10-Lead, Snap, IEC, 2.3m
		/	HA135S10A	14pin, 10-Lead, Snap, AHA, 2.3m
		RE-PC-IEC-BAN	HA135B10I	14pin, 10-Lead, Banana, IEC, 2.3m
		RE-PC-AHA-BAN	HA135B10A	14pin, 10-Lead, Banana, AHA, 2.3m
		SE-PC-IEC-CLIP	HA135C10I	14pin, 10-Lead, Clip, IEC, 2.3m
SE-PC-AHA-CLIP		HA135C10A	14pin, 10-Lead, Clip, AHA, 2.3m	

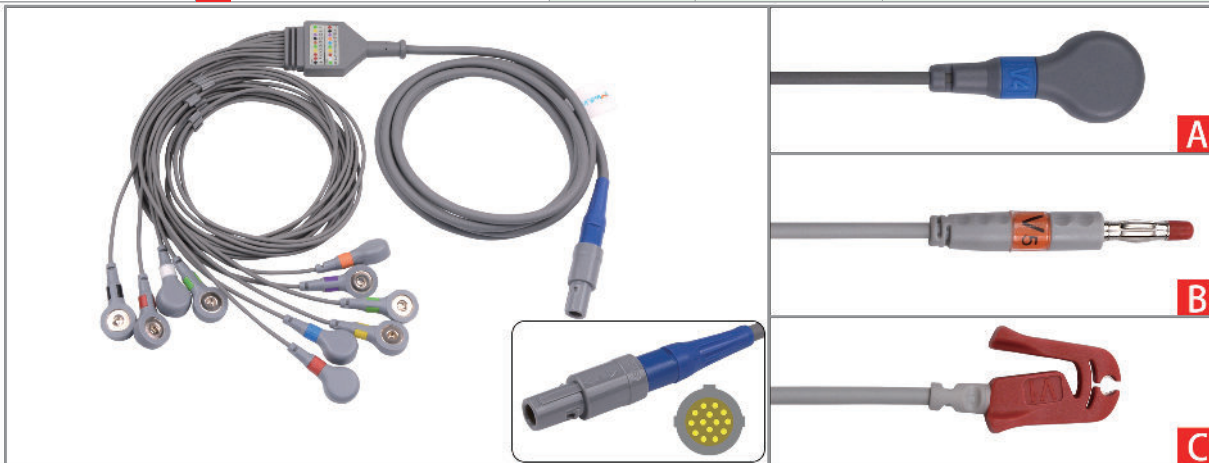







Compatible Models	Product Picture	OEM #	Order Code	Descriptions
Compatible (BI)/Brentwood				
Biomedical Instruments (BI): BI 9000 Brentwood: BH-3000			HC024-7A	Holter ECG Trunk Cables, 18in. (45cm), Din 7-Ld, AHA, fit for Din 1.5mm style LeadWires
BI 9800			HC024-10A	Holter ECG Trunk Cables, 18in. (45cm), 10-Ld, AHA, fit for Din style LeadWires
Compatible Biox				
Biox: CB-2300-A Biomedical Instruments (BI): BI9000TL			HC033-7A	Holter ECG Trunk Cables, 18in. (45cm), Din 7-Ld, AHA, fit for Din style LeadWires
Compatible Burdick				
92512 Holter			HC030-5A	Holter ECG Trunk Cables, 31 in. (80cm), Din 5-Ld, AHA, fit for Din style LeadWires
BI 9800			HC030-7A	Holter ECG Trunk Cables, 18in. (45cm), Din 7-Ld, AHA, fit for Din style LeadWires
Compatible Landcom				
			HC031-7A	Holter ECG Trunk Cables, 18in. (45cm), Din 7-Ld, AHA, fit for Din style LeadWires
			HC031-10A	Holter ECG Trunk Cables, 18in. (45cm), Din 10-Ld, AHA, fit for Din style LeadWires
Compatible Medilog				
Medilog: FD5			HC051-7A	Holter ECG Trunk Cables, 18in. (45cm), Din 7-Ld, AHA, fit for Din style LeadWires
Compatible GE-Marquette/Rozinn/GeTeMED				
For GE Marquette: 8000, 8200, 8500, SEER Holter Recorder model: 151		E9002TE	HC006-7A	Holter ECG Trunk Cables, 18in. (45cm), Din 7-Ld, AHA, fit for Din style LeadWires
Compatible GE-Marquette Rozinn				
For GE SEER MC Holter Recorder		E9002TK	HC047-5A	Holter ECG Trunk Cables, 31 in. (80 cm), Din 5-Ld, AHA, fit for Din style LeadWires
		E9002TL	HC047-7A	Holter ECG Trunk Cables, 31 in. (80 cm), Din 7-Ld, AHA, fit for Din style LeadWires
		E9002TP	HC047-10A	Holter ECG Trunk Cables, 31 in. (80 cm), Din 10-Ld, AHA, fit for Din style LeadWires



Compatible Models	Product Picture	OEM #	Order Code	Descriptions	Electrode end
Compatible Din 1.5 Style Normal					
Suitable for all Din-Plug System			EC024S3A	Din Holter Leadwires, 24 in. (61cm), 3-Ld, AHA	Snap
			EC024C3I	Din Holter Leadwires, 24 in. (61cm), 3-Ld, IEC	Grabber
			HC096S10A	Din Holter Leadwires, 96in(2.43m), 10-Ld, AHA	Snap
			HC096S10I	Din Holter Leadwires, 96in(2.43m), 10-Ld, IEC	Snap
			HC072S10A	Din Holter Leadwires, 72in(1.83m), 10-Ld, AHA	Snap
			HC072S10I	Din Holter Leadwires, 72in(1.83m), 10-Ld, IEC	Snap
			HC120S10A	Din Holter Leadwires, 120in(3.05m), 10-Ld, AHA	Snap
			HC120S10I	Din Holter Leadwires, 120in(3.05m), 10-Ld, AHA	Snap
			EC024S5A	Din Holter Leadwires, 24 in. (61cm), 5-Ld, AHA	Snap
			EC024S5I	Din Holter Leadwires, 24 in. (61cm), 5-Ld, IEC	Snap
			EC024C5I	Din Holter Leadwires, 24 in. (61cm), 5-Ld, IEC	Grabber
			EC040S3A	Din Holter Leadwires, 40 in. (102cm), 3-Ld, AHA	Snap
			EC040C3A	Din Holter Leadwires, 40 in. (102cm), 3-Ld, AHA	Grabber
			EC040C3I	Din Holter Leadwires, 40 in. (102cm), 3-Ld, IEC	Grabber
			EC040C3I-RL	Din Holter Leadwires, 40 in. (102cm), 3-Ld, IEC	Grabber (RL Style)
			EC040C3A-RL	Din Holter Leadwires, 40 in. (102cm), 3-Ld, AHA	Grabber
			EC040S5A	Din Holter Leadwires, 40 in. (102cm), 5-Ld, AHA	Snap
			EC040C5A	Din Holter Leadwires, 40 in. (102cm), 5-Ld, AHA	Grabber
			EC040S5I	Din Holter Leadwires, 40 in. (102cm), 5-Ld, IEC	Snap
			EC040C5I-RL	Din Holter Leadwires, 40 in. (102cm), 5-Ld, IEC	Grabber (RL Style)
			EC040C5A-RL	Din Holter Leadwires, 40 in. (102cm), 5-Ld, AHA	Grabber (RL Style)
			HC024S7A	Din Holter Leadwires, 24 in. (61cm), 7-Ld, AHA	Snap
			HC024S7I	Din Holter Leadwires, 24 in. (61cm), 7-Ld, IEC	Snap
			HC040S7A	Din Holter Leadwires, 40 in. (102cm), 7-Ld, AHA	Snap
			HC040S7I	Din Holter Leadwires, 40 in. (102cm), 7-Ld, IEC	Snap
			HC040C7I	Din Holter Leadwires, 40 in. (102cm), 7-Ld, IEC	Grabber
			HC018S10I	Din Holter Leadwires, 18 in. (45cm), 10-Ld, IEC	Snap
			HC024S10A	Din Holter Leadwires, 24 in. (61cm), 10-Ld, AHA	Snap
			HC040S10A	Din Holter Leadwires, 40 in. (102cm), 10-Ld, AHA	Snap
			HC040C10I	Din Holter Leadwires, 40 in. (102cm), 10-Ld, IEC	Grabber

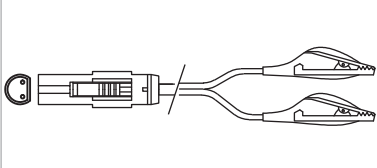

Compatible Models	Product Picture	OEM #	Order Code	Descriptions
Compatible Din 2.0 Plug Style				
Suitable for all Din 2.0 Plug System			HT040S3A	Din 2.0 plug lead wires, 40 in. (102cm), 3-Ld, AHA

Direct-Connect (one-piece) Temporary Pacemaker Leadwire				
Medtronic 5388 Temporary Pacemaker		5832	HC060C2AI	Reusable small clip short channel A or V 6ft
		5832S		Reusable small clip Long channel A or V 12ft
Medtronic 5318,5388,5348, 53401 Temporary Pacemaker			HC066C2A	Din 2mm plug with alligator clip
Temporary Pacemaker Cable				
Medtronic 5318,5388,5348, 53401 Temporary Pacemaker		5433A	HC062-2A	Atrial Use Reusable short channel A 6ft
		5433AL		Atrial Use Reusable long channel A 12ft
		5433V	HC062-2I	Ventricular Use Reusable short channel V 6ft
		5433VL		Ventricular Use Reusable long channel V 12ft
Temporary Pacemaker Cable and Leadwire				
Medtronic 5318,5388,5348, 53401 Temporary Pacemaker			HC067C2A	Din 2mm Sockets with alligator clip