



Diagnosis EKG Cable & Accessories

Specification

Cable Material	TPU jacket, light gray
Connector & Yoke	Golden plated pins Injection molding process
Trunk Cable Length	1.8m
Lead Wire Length	1.26m (limb lead); 0.76m (chest lead)
Connector Proximal	Banana, grabber (Clip), snap, 3mm needle

Compliance with

ANSI/AAMI EC53
 IEC 60601-1
 ISO 10933-1
 ISO 10933-5
 ISO 10933-10

CONTENTS ►►►

1. Direct-Connect EKG Cables	231	▶
2. EKG Trunk Cables	237	▶
3. EKG LeadWires	239	▶
4. EKG Accessories	242	▶

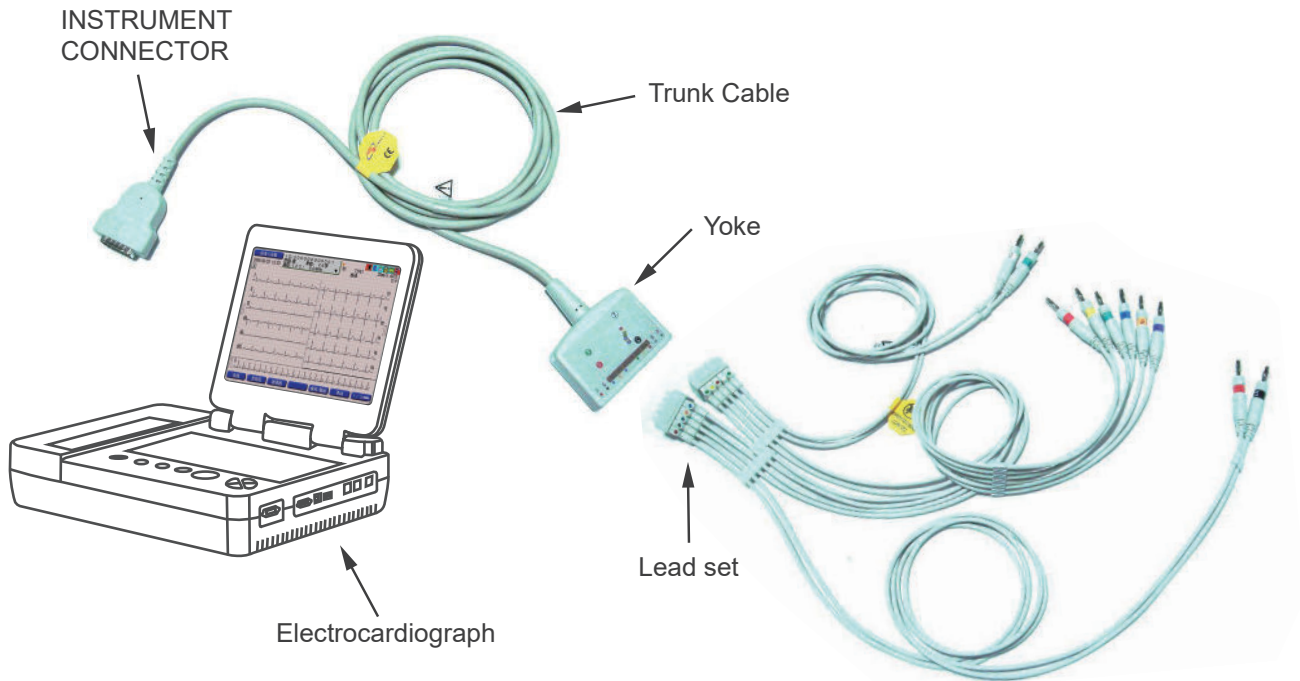

Type Designation

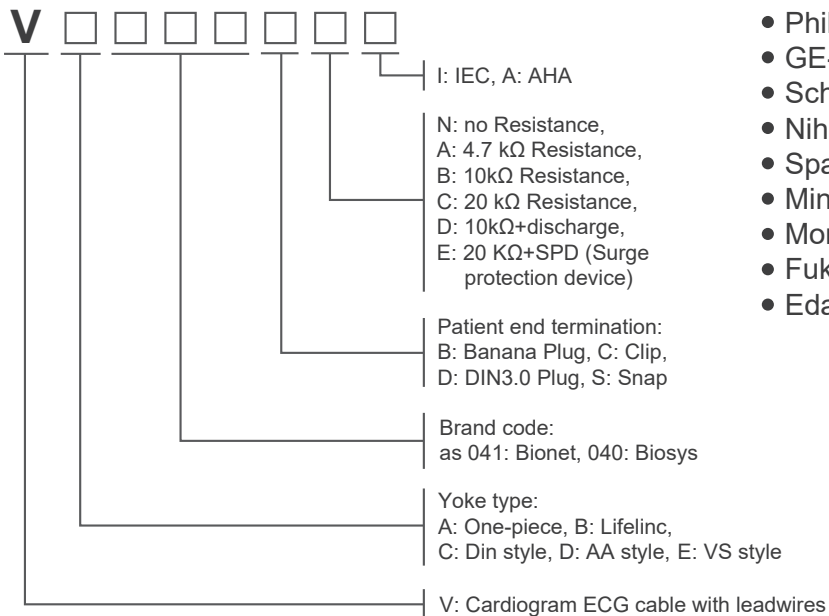

Mainly Compatible Brands

- Philips
- GE-Marquette
- Schiller
- Nihon Kohden
- Spacelabs
- Mindray (China)
- Mortara
- Fukuda Denshi
- Edan (China)

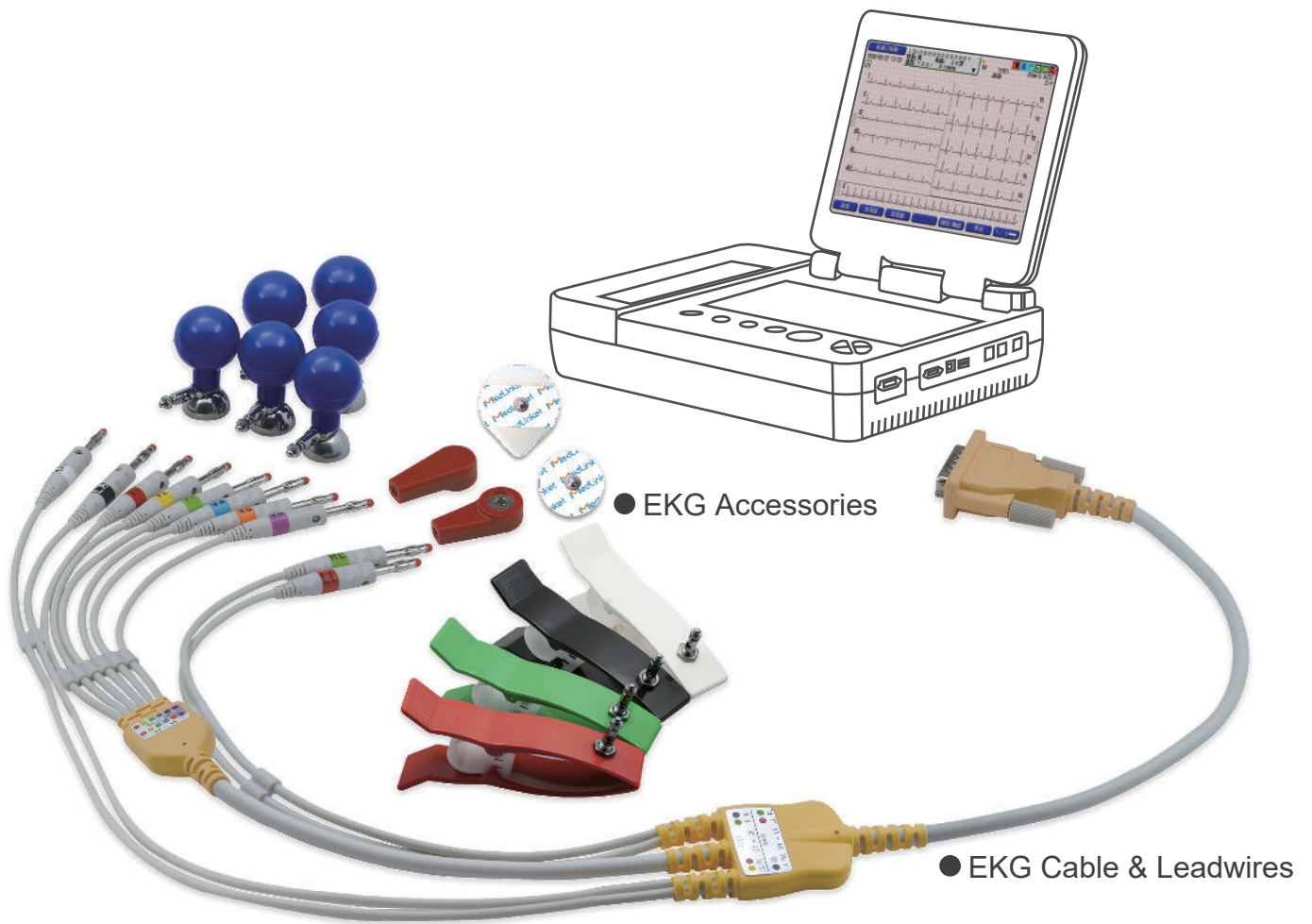

Lead Position Marked

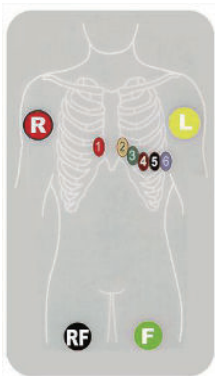

12 Lead: I
Standard IEC

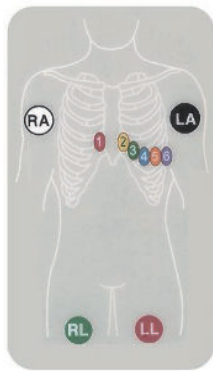

12 Lead: A
Standard AHA

S: Standard Snap



C: Clip (type RL Grabber)



D: Din 3.0



B: Banana 4.0



Code	AHA (A)	IEC (I)	Alternate IEC
Snap End	<p>RL RA V1 V2 V3 V4 V5 V6 LA LL</p>	<p>N R C1 C2 C3 C4 C5 C6 L F</p>	<p>L R C1 C2 C3 C4 C5 C6 F RF</p>
Grabber End	<p>RA RL V1 V2 V3 V4 V5 V6 LA LL</p>	<p>N R C1 C2 C3 C4 C5 C6 L F</p>	<p>L R C1 C2 C3 C4 C5 C6 F RF</p>
4mm Banana end	<p>RL RA V1 V2 V3 V4 V5 V6 LA LL</p>	<p>N R C1 C2 C3 C4 C5 C6 L F</p>	<p>L R C1 C2 C3 C4 C5 C6 F RF</p>
3mm Needle end	<p>RA RL V1 V2 V3 V4 V5 V6 LA LL</p>	<p>N R C1 C2 C3 C4 C5 C6 L F</p>	<p>L R C1 C2 C3 C4 C5 C6 F RF</p>

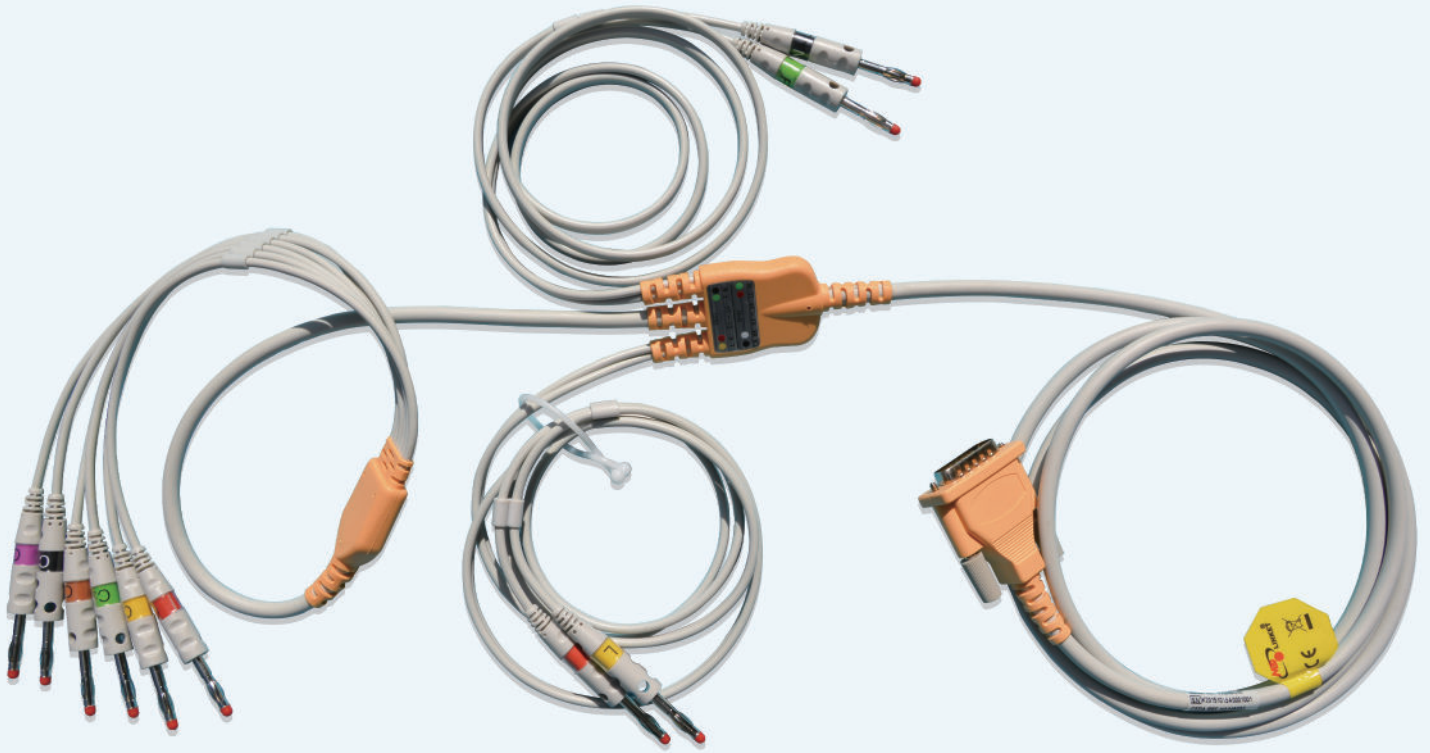

1 Direct-Connect EKG Cables

Product Features

1. Integrated design, convenient for use and maintenance;
2. Meeting the requirements of EC53;
3. Outstanding shielding property, Reduces the risk of Electromagnetic Interference (EMI);
4. Excellent defibrillation-proof performance, protecting the equipment well;
5. Flexible and durable cables;
6. Outstanding cable material, enduring repeated cleaning and disinfection;
7. Latex free.



OEM Manufacturer & Models	Connector	OEM #	Order Code	Descriptions
Compatible Burdick				
EK-10, E350, E350I, E550, E560, Eclipse LE, EK10, Elite, Elite II		012-0700-00, 7517, 7514, 7705, 7706	VA002BNI	Banana, No Resistance, IEC
			VA002BNA	Banana, No Resistance, AHA
			VA002CNI	Grabber, No Resistance, IEC
Burdick Quinton Eclipse 4, 8, 400, 800, 850, Plus and Elite II, ATRIA Plus Quinton			VA004BAI	Banana, 4.7kΩ Resistance, IEC
			VA004BNI	Banana, No Resistance, IEC
			VA004DNI	Din3.0, No Resistance, IEC
Eclipse 4/400/8/800/850/ 850I, Eclipse Plus, Atria 3000		007704, 007725, 012-0844-00, 012-0844-01, 007785	VA005BBA	Banana, 10kΩ Resistance, AHA
			VA005BBI	Banana, 10kΩ Resistance, IEC
Compatible Edan (China)				
Edan: SE-1010PC, SE-12, SE-12 Express, SE-1200, SE-3, SE-601A, SE-601B, SE-601C, ST-1212 Datascope: DECG-03A Nihon Kohden: BSM-2301K Spacelabs: SL6		01.57.107048, 01.57.471017	VA030BBI	Banana, 10kΩ Resistance, IEC
			VA030BBA	Banana, 10kΩ Resistance, AHA
			VA030CBI	Grabber, 10kΩ Resistance, IEC
			VA030SBI	Snap, 10kΩ Resistance, IEC
Compatible Fukuda Denshi				
CardiMax FX-7202/7402-710/ 7102, FCP 2155, FCP 2201, FCP 4101, FCP 4101A, FX-101, FX-102F, FX-3010, FX-328UY			VA017BAI VA017BAA	Banana, 4.7kΩ Resistance, IEC/AHA
			VA017DAI	Din3.0, 4.7kΩ Resistance, IEC
			VA017BBI	Banana, 10kΩ Resistance, IEC
			VA017CAI	Grabber, 4.7kΩ Resistance, IEC
Compatible Fukuda Me				
Cardisuny, KP-500, KP-500D			VA024BNI	Banana, No Resistance, IEC
			VA024SNA	Snap, No Resistance, AHA
FX-031			VA014BNA	Banana, No Resistance, AHA
			VA014DNI	Din3.0, No Resistance, IEC
Compatible GE-Marquette				
MAC 1000, MAC 1100, MAC 1200, MAC 1600, MAC 2000, MAC 3500, MAC 400, MAC 500, MAC 600, MAC 800, Microsmart M		Sage P/N: A02-10B	VA008BBI VA008BBA	Banana, 10kΩ Resistance, IEC/AHA
			VA008CBA VA008CBI	Grabber, 10kΩ Resistance, AHA/IEC
			VA008DBA VA008DBI	Din3.0, 10kΩ Resistance, AHA/IEC
			VA008SBI	Snap, 10kΩ Resistance, IEC



OEM Manufacturer & Models	Connector	OEM #	Order Code	Descriptions
Compatible Hellige/Siemens/Bosch				
Hellige: Cardiosys, EK36, EK403, EK41, EK413, EK43, EK512, EK53 Siemens: Cardiostat1/3T/703/710/31/31S Bosch: 603 D, 603 ER, 603 S, 606			VA029BAI	Banana, 4.7kΩ Resistance, IEC
			VA029BNI	Banana, No Resistance, IEC
			VA029SAI	Snap, 4.7kΩ Resistance, IEC
			VA029CNI	Grabber, No Resistance, IEC
Compatible Kenz/Cardioline				
Kenz: 103, 106, 107, 1201, 302, 303 Cardioline: Delta 1, Delta 1 Plus, Delta 3, Delta 3 Plus, Delta 30, Delta 30D, Delta 60, Delta 60 Plus, ECG 10610, 1210, 1211, 601, Cardico 302		PC-104, 63050074, 63050075, 895.0586	VA016BAI	Banana, 4.7kΩ Resistance, IEC
			VA016SAI	Snap, 4.7kΩ Resistance, IEC
			VA016BNI	Banana, No Resistance, IEC
			VA016CNI	Grabber, No Resistance, IEC
			VA016SNI	Snap, No Resistance, IEC
Kenz: 108, 109, 110, 1210, 1211, 601, Cardico 302		K131	VA015BNA VA015BNI	Banana, No Resistance, AHA/IEC
			VA015DNI	Din3.0, No Resistance, IEC
Compatible Medtronic				
Lifepak 11, Lifepak 12, Lifepak 15, Lifepak 20			VA013SBI	Snap, 10kΩ Resistance, IEC
Compatible (China)				
DPM6, DPM7, Passport 12mm, Passport 17m, T1			VA020BBA	Banana, 1kΩ Resistance, AHA
			VA020CBA VA020CBI	Grabber, 1kΩ Resistance, AHA/IEC
			VA020SBI	Snap, 1kΩ Resistance, IEC
Compatible Mortara				
ELI 100, ELI 50, ELI 200 Landscape, Portrait, Xscribe DOS			VA025BAA VA025BAI	Banana, 4.7kΩ Resistance, AHA /IEC
Martara Surveyor			VA035SBI	Snap, 10kΩ Resistance, IEC



OEM Manufacturer & Models	Connector	OEM #	Order Code	Descriptions
Compatible Nihon Kohden, Biocare/Cardioline				
BIOCARE: 101B, 101G, 1200, 300, 300G, 9803, ECG-101 Cardioline: AR1200 viewBT, AR1200adv, AR2100 viewBT, AR2100adv, AR600adv Nihon Kohden: ECG-9620/9010/9020, ECG-9022/9110/9130/9132/ Dongjiang		BA-902D	VA001BNA VA001BNI	Banana, No Resistance, AHA/IEC
		BA-903D	VA001CNI	Grabber, No Resistance, IEC
		BA-901D	VA001DNI	Din3.0, No Resistance, IEC
			VA001BAA VA001BAI	Banana, 4.7kΩ Resistance, AHA/IEC
			VA001DAA	Din3.0, 4.7kΩ Resistance, AHA
			VA001SAI	Snap, 4.7kΩ Resistance, IEC
BSM-2301, BSM-2353, BSM-5100			VA036SNI	Snap, No Resistance, IEC
		BJ-900P	VA036CNI	Grabber, No Resistance, IEC
Nihon Kohden: Cardiofax Q ECG-9110K Cardiofax Q ECG-9130K ECG-9130P, ECG-9620P special screw, imperial standard(SAE)			VA009BNI	Banana, No Resistance, IEC
			VA009DNI	Din3.0, No Resistance, IEC
			VA009SNI	Snap, No Resistance, IEC
5151A, 5403A, 5503A, 5504A, 6151, 6151A, 6151B, 6306A, 6353, 6353A, 6543A, 6851, 8110, 8330, 8330A, Cardiofax, Escape 12		45502-NK	VA004BNI	Banana, No Resistance, IEC
			VA004DNI	Din3.0, No Resistance, IEC
ECG-9320 ECG-9522P (Original part No.: BR-911D)			VA010DCA	Din3.0, No Resistance, AHA
			VA010CCI	Grabber, No Resistance, IEC
Compatible Petas (Turkey)				
			VA023BNI	Banana, No Resistance, IEC
Compatible Philips				
Philips: 200, 200i, Agilent 300PI, Agilent 300i, M1770A, M1771A, M1772A, Pagewriter 100/200, Pagewriter 300PI/TC20 Burdick: ELI 150, ELI 210, ELI 230, ELI 250, ELI 250C, ELI 350 Spacelabs: CardioDirect 12 Welch Allyn: CP 10, CP 150, CP 20, CP 250, CP 50		Philips P/N: M2461A, M3702C, 989803107711	VA018BCA VA018BCI	Banana, 20kΩ Resistance, AHA/IEC
		Burdick P/N: 9293-033-50, 9293-033-52	VA018SCA VA018SCI	Snap, 20kΩ Resistance, AHA/IEC
			VA018BCA-U	Grabber, 20kΩ Resistance, AHA
		Burdick P/N: 9293-042-50, XCLCCMD01A	VA018CCI	Grabber, 20kΩ Resistance, IEC



OEM Manufacturer & Models	Connector	OEM #	Order Code	Descriptions
Compatible Philips				
Philips PageWriter TC10			VA066SFA	Snap, 3.3kΩ Resistance, AHA
			VA066SFI	Snap, 3.3kΩ Resistance, IEC
			VA066CFA	Grabber, 3.3kΩ Resistance, AHA
			VA066CFI	Grabber, 3.3kΩ Resistance, IEC
			VA066BFA	Banana, 3.3kΩ Resistance, AHA
		989803184921 989803184941	VA066BFI	Banana, 3.3kΩ Resistance, IEC
			VA066NFA	Needle, 3.3kΩ Resistance, AHA
			VA066NFI	Needle, 3.3kΩ Resistance, IEC
Philips PageWriter TC20			VA065SBA	Snap, 10kΩ Resistance, AHA
			VA065SBI	Snap, 10kΩ Resistance, IEC
			VA065CBA	Grabber, 10kΩ Resistance, AHA
			VA065CBI	Grabber, 10kΩ Resistance, IEC
			VA065BBA	Banana, 10kΩ Resistance, AHA
		989803179441 989803175911	VA065BBI	Banana, 10kΩ Resistance, IEC
			VA065NBA	Needle, 10kΩ Resistance, AHA
			VA065NBI	Needle, 10kΩ Resistance, IEC



OEM Manufacturer & Models	Connector	OEM #	Order Code	Descriptions
Compatible Spacelabs				
90367, 90369, 90496, 91496, Ultraview Module			VA027CBI	Grabber, 1 kΩ Resistance, IEC
			VA027BBA	Banana, 1 kΩ Resistance, AHA
		Sage P/N: A03-12S	VA027SBI	Snap, 1 kΩ Resistance, IEC
Compatible Schiller				
Schiller: AT3, AT5, AT6, AT10, AT60, AT104 PC, AT104, AT101, CS6, CS12, CS100, CS200 Trentina : All Excel-Types	Short Screw 		VA021BBA VA021BBI	Banana, 10kΩ Resistance, AHA/IEC
			VA021BNA VA021BNI	Banana, No Resistance, AHA/IEC
			VA021BDA VA021BDI	Banana, 10kΩ+SPD, AHA/IEC
			VA021CBI	Grabber, 10kΩ Resistance, IEC
			VA021CNI	Grabber, No Resistance, IEC
			VA021SNI	Snap, No Resistance, IEC
Schiller: AT-2 Plus, AT1, AT2, AT4, AT101, AT102 Datascope: BeneHeart R3 Esaote Biomedica: P80,P80Power, P80PowerSix	Long Screw 	2.400095, 2.400071E, 2.400071S, MD07J	VA022BBA VA022BBI	Banana, 10kΩ Resistance, AHA/IEC
		2.400116E	VA022CBI	Grabber, 10kΩ Resistance, IEC
		2.400116S	VA022SBA	Snap, 10kΩ Resistance, AHA
			VA022DBI	Din3.0, 10kΩ Resistance, IEC
AT101, AT-2 Plus, AT1, AT2, AT4, AT102			98122841015	Din3.0, No Resistance, IEC
Compatible Trentina, Also See Compatible Schiller				
All Excel-Types			VA031BNI	Banana, No Resistance, IEC
			VA031CNI	Grabber, No Resistance, IEC
			VA031SNI	Snap, No Resistance, IEC
		See Compatible Schiller VA021 Series		
Compatible ZOLL				
E Series, M Series		8000-1007-02 8000-1007-01 8000-1006-02	VA034SBI	Snap, 10kΩ Resistance, IEC



2 EKG Trunk Cables

Product Features

1. Easy to replace leadwires;
2. Meeting the requirements of EC53;
3. Outstanding shielding property, Reduces the risk of Electromagnetic Interference (EMI);
4. Excellent defibrillation-proof performance, protecting the equipment well;
5. Flexible and durable cables;
6. Outstanding cable material, enduring repeated cleaning and disinfection;
7. Latex free.



OEM Manufacturer & Models	Instrument Connector	Yoke Connector	OEM #	Order Code	Descriptions
Compatible GE Healthcare					
GE Hellige: MicroSmart, MAC 500/ 1100/1200/1200 ST			223 418 08	VE008-BAI	2.2m, 10kΩ resistance, AAMI/IEC fit for Multi-link (VS) style Lead Wires AS VE008BNI and VE008BNI
CAM 14, CASE, MAC 5000, MAC 5500			2016560-001, 700657-001, E9001YT	VF008-N	EKG Trunk Cable 50in. (130cm)
				VF008-15	EKG Trunk Cable 15ft. (450cm)
Compatible Schiller/Trentina/Bionet (Korea)					
Schiller: AT3, AT5, AT6, AT10, AT60, AT104 PC, AT104, CS6, CS12, CS100, CS200 Trentina: All Excel-Types Bionet: All Excel-Types			700-0008-01	VE021-NAI	2.2m, no resistance, 10kΩ AAMI/IEC fit for Multi-link (VS) style Lead Wires AS VE008BNI, VE008CNA
Compatible Philips					
XLI M1719A				V0018D	Philips DB9M Trunk Cable + Philips DB9M Trunk Cable, 8.5ft (260cm), 1pcs/pk



3 EKG LeadWires



Product Features

1. Easy to replace trunk cables;
2. Meeting the requirements of EC53;
3. Outstanding shielding property, Reduces the risk of Electromagnetic Interference (EMI);
4. Flexible and durable cables;
5. Outstanding cable material, enduring repeated cleaning and disinfection;
6. Latex free.



OEM Manufacturer & Models	Product Guide	OEM #	Order Code	Descriptions	Standard	Electrode End
Compatible CONMED/JINJIANG						
Jinjiang Electronic Tech instrument: LEAD2000, GE electrophysiology machine			VG019SNA VG019SNI	10-Ld EKG LeadWires 4 x limb lead (130 cm) 6 x chest leads (70 cm) No Resistance	AHA/IEC	Snap
Compatible GE Healthcare						
MAC 1000, MAC 1100, MAC 1200, MAC 1600, MAC 2000, MAC 3500, MAC 400, MAC 500, MAC 600, MAC 800, Microsmart M		38401816	VE008BNA	EKG LeadWires 4 x imb lead (130 cm), 6 x chest leads (70 cm) Twin Pin, Grouped, 2 sets, No Resistance	AHA	Banana
			VE008BNI		IEC	
			VE008SNA		AHA	Snap
			VE008SNI	EKG LeadWires 4 x limb lead (130 cm), 6 x chest leads (70 cm) Twin Pin, Grouped, 2 sets, No Resistance	IEC	
			VE008CNI		IEC	Grabber (Clip)
		2104724-001	VE008BNA-10		Banana, AHA, No Resistance, Chest leads 32in, Limb leads 49in	AHA
2104751-001		VE008BNA-04		Banana, AHA, No Resistance Chest leads 32in, (E, H, M, I)	AHA	Banana
CAM 14, CASE 8000, CASE Series, CardioSmart, CardioSoft, CardioSys, MAC 1100, MAC 1200, MAC 1600, MAC 3500, MAC 5000, MAC 5000ST, MAC 5500		E9006PJ	VE008A29	Leadwire, CAM/Universal, 29 in. (74 cm), 6 pcs/pk, No Resistance		
		E9006PK	VE008A40	Leadwire, CAM/Universal, 40 in. (102 cm), 6 pcs/pk, No Resistance		
		E9006PL	VE008A51	Leadwire, CAM/Universal, 51 in. (130 cm), 4 pcs/pk, No Resistance		
		E9006PM	VE008A26	Leadwire, CAM/Universal, 26 in. (66 cm), 6 pcs/pk, No Resistance		
		E9006PN	VE008A36	Leadwire, CAM/Universal, 36 in. (90 cm), 6 pcs/pk, No Resistance		
Compatible Mortara						
AM12, Wireless Acquisition Module (WAM) Burdick: ELI 150C, ELI 230, ELI 250C, ELI 280, ELI 350		9293-041-50 9293-046-60	VT047BNA VT047BNI	12-Ld EKG LeadWires 4 x limb lead (120 cm), 6 x chest leads (80 cm) No Resistance	AHA IEC	Banana
		9293-047-60	VT047CNA VT047CNI	12-Ld EKG LeadWires 4 x limb lead (120 cm), 6 x chest leads (80 cm) No Resistance	AHA IEC	Grabber (Clip)
			NEW VT047SNI VT047SNA	12-Ld EKG LeadWires 4 x limb lead (120 cm), 6 x chest leads (80 cm) No Resistance	AHA IEC	Snap



OEM Manufacturer & Models	Product Guide	OEM #	Order Code	Descriptions	Standard	Electrode End
Compatible Mortara						
AM12, Wireless Acquisition Module (WAM) Burdick: ELI 150C, ELI 230, ELI 250C, ELI 280, ELI 350			VT047CBI	12-Ld EKG LeadWires 4 x limb lead (120 cm), 6 x chest leads (80 cm), No Resistance	IEC	Grabber (Clip)
Compatible Philips						
860306, 860310, 860315, PageWriter TC30/TC50/TC70		989803151631	VA051BNI	4 x limb lead (70 cm), 6 x chest leads (70 cm), 1kΩ	IEC	Banana
Philips CardioDynamics BioZ, M1701A, PageWriter PIM module - 989803130091, PageWriter PIM module - 989803130101, PageWriter TC70, PageWriter Trim I, PageWriter Trim II, PageWriter Trim III, PageWriter XLE 1702A, PageWriter XLI M1700A, PageWriter Touch, Sonosite, Trim		989803129161	VX018BNA	4 x limb lead (130 cm), 6 x chest leads (80 cm), No Resistance	AHA	Banana

